



CLAUDIA NÄSER & MANJA WETENDORF

THE MUSAWWARAT POTTERY PROJECT 2014/15

In 2014, investigations recommenced in ‘pottery courtyard’ 224 of the Great Enclosure – exploring a substantial ceramic deposit which was first identified in the 1990s.¹ The present report details the activities and findings of the 2014 autumn and 2015 spring seasons. Work focused on the continued exploration of the nature of the deposit, on producing data which would help to clarify the supposed pottery production in the area and, finally, on the analysis of the recovered pottery and related finds themselves.

ARCHAEOLOGICAL INVESTIGATIONS IN COURTYARD 224

A new trench, 224.15, was laid out west of trenches 224.12 and 224.14 (fig. 1) which had been investigated in 1997 and 2014 respectively.² The aim was to explore the extent of the pottery deposit and the brick structure detected in 224.14 to the west, and to recover further sherd material. Trench 224.15 measured 2 x 5m and was internally subdivided into two 2 x 2m squares with a 1m-bulk in between.³

1 See Näser and Wetendorf 2014 for bibliographical details. The current research has been conducted with funding from the Qatar-Sudan Archaeological Project and the Berlin Cluster of Excellence TOPOI, whose support is gratefully acknowledged. See also <http://www.musawwarat.com/> and <http://www.topoi.org/project/a-6-5/>. Work in the field was undertaken by Claudia Näser (archaeology, small find analysis), Christiane Dorstewitz (archaeology), Manja Wetendorf (archaeology, pottery analysis), Stephanie Bruck (archaeology, pottery analysis, pottery and find drawing), Jaroslav Halik (pottery and find drawing). The archaeometric analyses are undertaken by Malgorzata Daszkiewicz and Gerwulf Schneider, who are thanked for the fruitful cooperation. The authors would like to express their gratitude to the National Corporation for Antiquities and Museums of Sudan, in particular towards Dr Abdelrahman Ali Mohamed, for facilitating the export of samples and finds for study in Berlin. We are also grateful to Gemma Tully who corrected the English of this contribution. Special thanks go to Christiane Dorstewitz for her dedicated work in the field and for her support in preparing this report.

2 See Wenig and Wolf 1999; Edwards 1998, 1999; Onasch 2004; Näser and Wetendorf 2014.

3 224.15 thus corresponds to what had first been laid out as the two western squares of 224.14; see the description of the original 5 x 5m layout of 224.14 in Näser and Wetendorf

Excavation commenced in the northern square and was later expanded into the southern square, with the bulk being finally removed.

A package of sandy layers constituted the top-most stratigraphic component (figs. 2–4, colour figs. 5–6). Layer 224.15-001 consisted mainly of wind-blown sand. Context 224.15-018 seems to constitute a recent disturbance south of wall 224/N connected to the re-erection of the enclosure wall in 2004, which was subsequently filled with material similar to 224.15-001 – thus obscuring the boundary between the layers. Layer 224.15-027 has a comparable but somewhat darker matrix and shows, in contrast to 225.15-001 almost no lamination. In the western section (figs. 2, 4, colour fig. 5), layer 224.15-027 blends into context 224.15-016 which is a lens of more reddish sandy-silty material, but again the boundary between the layers is ill defined. Context 224.15-017 is a sand-filled pit cut by the eastern section (fig. 3, colour fig. 6). It seems to mark a disturbance of unclear origin; as it contains several large sandstone blocks from wall 224/N it must postdate the (partial) collapse of this wall.⁴

This package of apparently recent and sub-recent layers, which is about 8 to 30cm deep, directly overlies the main ceramic deposit, 224.15-002 (figs. 2–4, colour fig. 5–6). Directly in front of wall 224/N the maximum depth of the deposit is c. 75cm, as compared to 80cm in trench 224.14.⁵ Towards the southwest, the deposit becomes gradually shallower. It is still 44cm deep at the southern end of the eastern section (fig. 3), but only 32cm in the western section (figs. 2, 4). It therefore seems most pronounced in trench 224.14 where it measured 50–55cm at the southern edge of the trench, while it was only 40cm deep in trench 224.12.⁶ As described in earlier publications,⁷ the matrix of the deposit consisted of an extremely loose dusty grey material, mixed with plenty of finds. As this consistency made excavation

2014: 74.

4 The pit seems to correspond to a disturbance in the western section of trench 224.14 where part of the section collapsed during excavation; cf. Näser and Wetendorf 2014: fig. 2.

5 Näser and Wetendorf 2014: 74, fig. 2.

6 Näser and Wetendorf 2014: 74, fig. 2; Edwards 1999: fig. 6.

7 Edwards 1999; Näser and Wetendorf 2014.

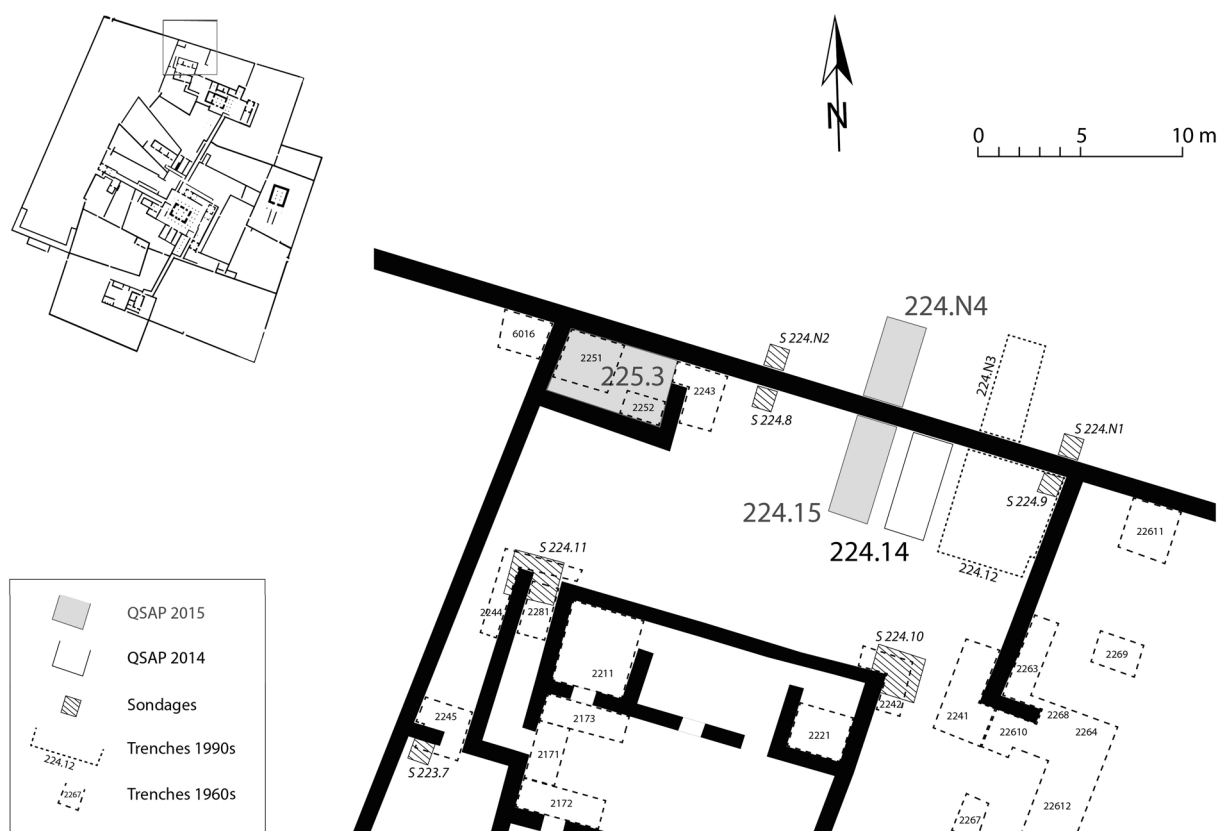


Fig. 1: Excavation plan of 'pottery courtyard' 224 and surroundings (cartographic and graphic implementation: Christiane Dorstewitz)

difficult, the deposit was dug in artificial layers of c. 20cm depth.⁸ On average, 1750 sherds were recovered per square meter of deposit.⁹ The third major component of the deposit was sandstone chunks and smaller sandstone fragments. Trench 224.15 figured several concentrations of these, particularly close to wall 224/N and in the southeast corner of the trench (figs. 2–4, colour figs. 5–6). Similar concentrations were reported from trench 224.12 in the northeastern corner of courtyard 224, while trench 224.14 had produced an altogether smaller amount of such sandstone rubble.¹⁰ As in trench 224.12, many of the stones from 224.15 showed signs of burning, which had not been noted to the same degree in the material from 224.14. The deposit also contained highly fragmented animal bones and other small finds.¹¹

The matrix of the deposit was a very loose grey material, which had been identified as ash from the

outset of the investigation.¹² While it was rather similar throughout the deposit, some internal differentiation was evident in the differing quantities of pottery and stone (figs. 2–4, colour figs. 5–6). This was particularly clear in the western section, which also shows lenses of unfired clay material in the lower part of the deposit (fig. 2: 224.15-004, 005, 022; fig. 3: 224.15-015). As already stated with regard to the findings in trench 224.14,¹³ while these features apparently represent individual dumping episodes, they were too inarticulate to obtain a coherent idea about the accumulation process of the deposit. Noteworthy again, however, is the absence firstly of any lamination or sandy layers within the deposit, which would testify to aeolian and fluvial impacts, and secondly of compacted layers of sherds or other find material which might have indicated the aeolian removal of such sediments from the deposit.¹⁴

8 Cf. Näser and Wetendorf 2014: 74, fig. 3.

9 See below, p. 40–41.

10 Edwards and Onasch in Edwards 1999: 10; Näser and Wetendorf 2014: 74.

11 See below, p. 52–55.

12 Seiler 1998: 56; Wenig und Wolf 1998a: 29–33, 1998b: 44; Edwards 1998: 64, 1999: passim; Näser and Wetendorf 2014: 74.

13 Näser and Wetendorf 2014: 75.

14 Dito already Edwards 1999: 37 and Näser and Wetendorf 2014: 75, contra Wenig and Wolf 1999: 30.

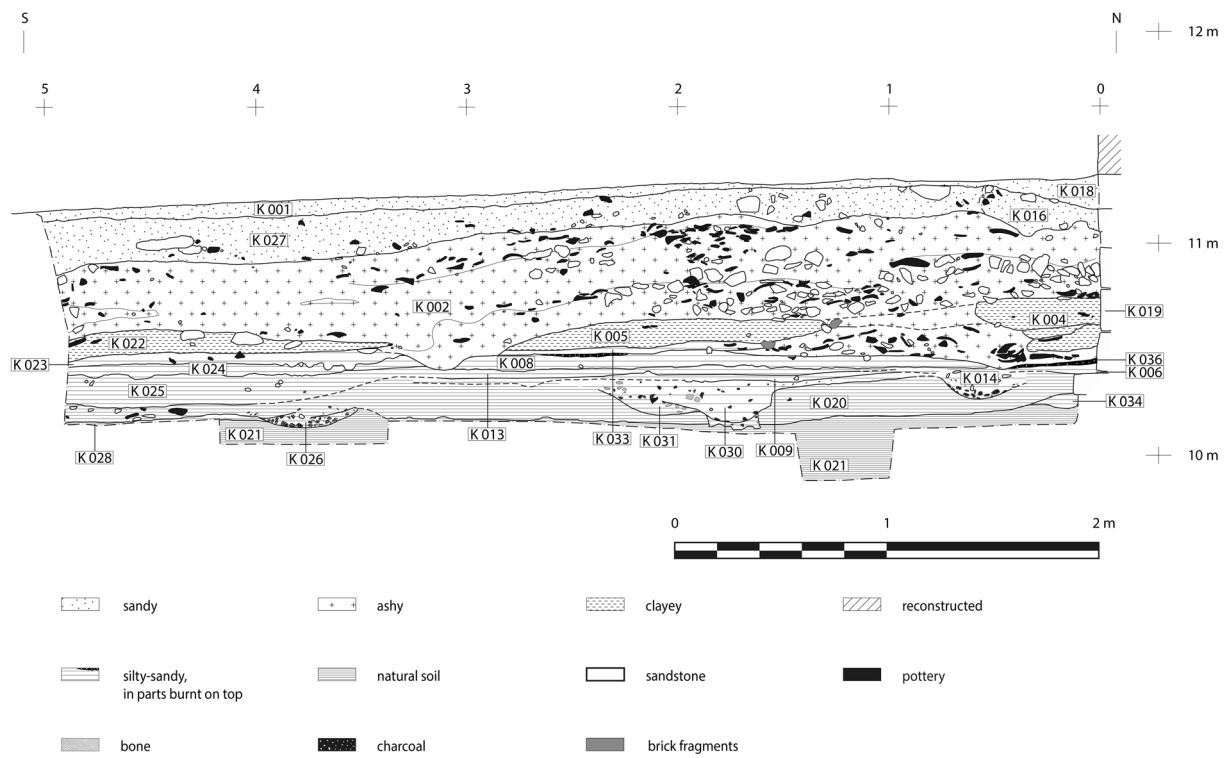


Fig. 2: Western section of trench 224.15 (drawing: Christiane Dorstewitz, Claudia Näser; graphic implementation: Christiane Dorstewitz)

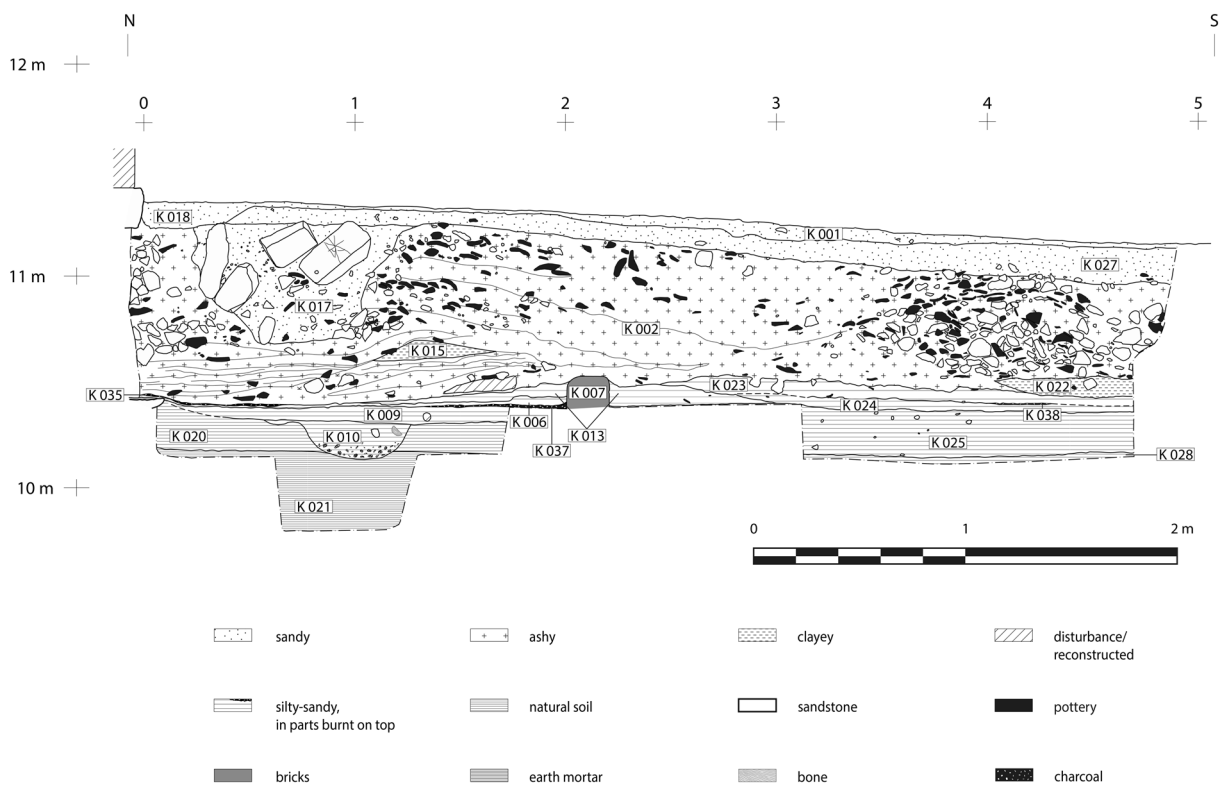


Fig. 3: Eastern section of trench 224.15 (drawing: Christiane Dorstewitz, Claudia Näser; graphic implementation: Christiane Dorstewitz)



Fig. 4: Western section of trench 224.15 with room 225 in the background (photo: Claudia Näser)

Underneath the main deposit, several layers followed which were clearly different in composition, but also appear to be the remnants of dumping episodes and are, in that respect, similar to layer 224.15-002. These are:

- 224.15-033, a packing of light reddish material including chunks of disintegrated bricks or a darker reddish material (fig. 2)
- 224.15-008 with a yellowish to light brown loose matrix (fig. 2), similar to 224.15-023, containing many small barrels of unburnt clay; at the top this layer shows a localised area of burning which may be the result of a fire or the deposition of charred material in this place
- 224.15-023 with a yellowish to light brown loose matrix (figs. 2–3); it contains a few potsherds and sandstone chips, and displays localised areas of burning in the plane
- 224.15-024, a light yellowish layer of compact silty-sandy material (figs. 2–3), in parts laminated, which may either be the lowest part of the deposition of layer 224.15-023, occupying the same relative position as 224.14-008, or an underlying floor level.

From their composition and position, it is assumed that these layers represent dumping episodes at, or immediately prior to, the outset of the formation of the main deposit. Two ¹⁴C dates very consistently place them in the 1st or 2nd centuries AD:

Poz-73426 (Musa15 224.15-023-002): 1900 ± 30 BP
68.2% probability
69AD (68.2%) 130AD
95.4% probability
28AD (1.9%) 39AD
50AD (88.5%) 180AD
186AD (5.0%) 214AD

Poz-73434 (Musa15 224.15-024-002): 1900 ± 30 BP
68.2% probability
69AD (68.2%) 130AD
95.4% probability
28AD (1.9%) 39AD
50AD (88.5%) 180AD
186AD (5.0%) 214AD

Unexpectedly, these dates are at the upper end of the date range obtained last year for a sample from the main deposit (Poz-63159) which was at 2010 ± 30 BP i.e. 61BC (91.2%) 65AD, 92BC (4.2%) 68BC.¹⁵ As the relative position of layers 224.15-023 and 224.15-024 with regard to the main deposit 224.15-002 is unquestionable (figs. 2–3), this can only mean that either the main deposit indeed dates to the very end of this range i.e. the second half of the 1st century AD, that the charcoal sample is intrusive in this find context, or that the deposit and the sample are contemporary and were re-deposited in their current position on top of ‘younger’ layers.¹⁶

¹⁵ Näser and Wetendorf 2014: 78.

¹⁶ For the discussion of these scenarios see below, p. 68–70.

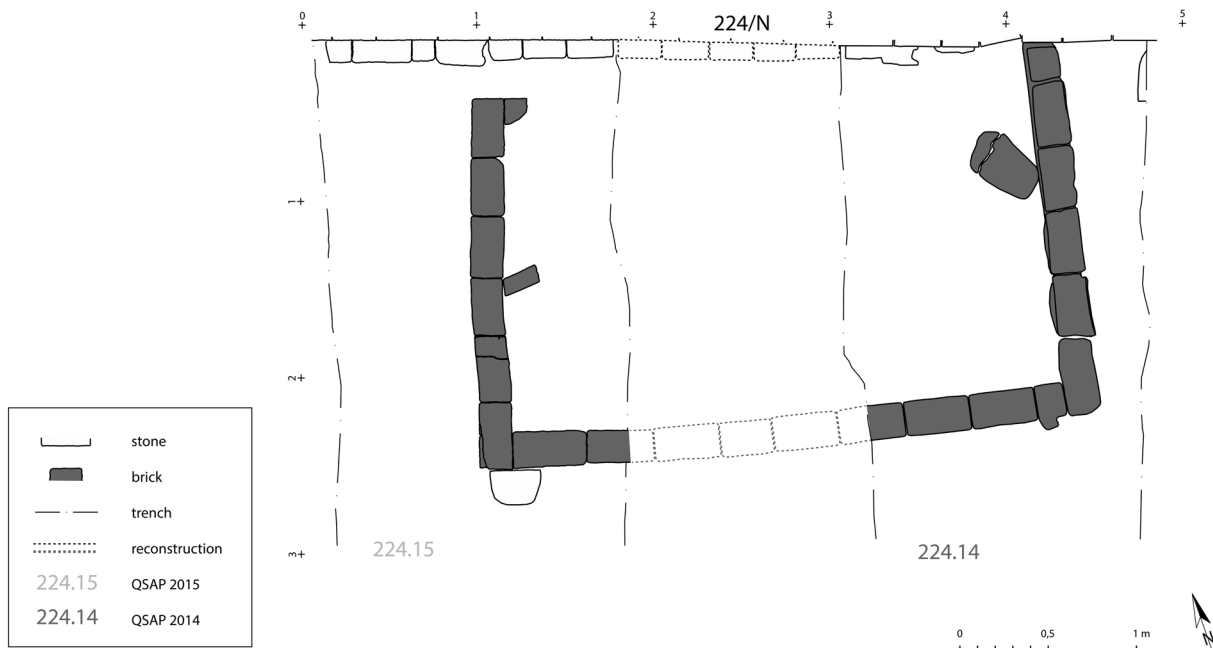


Fig. 5: Brick structure (224.14-004 = 224.15-007), central part hidden under the excavation bulk (drawing and graphic implementation: Christiane Dorstewitz)

Underneath the layers interpreted as representing dumped material, the next main stratigraphic context is mudbrick wall 224.15-007 (fig. 3). It is the expected continuation of a structure detected in neighbouring trench (224.14-004), a simple construction built in a single row of stretchers, abutting wall 224/N in slightly obtuse angle, enclosing a space of c. 3 x 2m, with a one brick wide gap in the west (fig. 5). Like in trench 224.14, the wall was only two bricks high.¹⁷ Since there was no substantial collapse, it must either have been a low construction or it was torn down deliberately in antiquity with the excess material being removed. The bricks of the wall appear to have been burnt secondarily, and some of their mud was 'washed' down on both sides of the wall, constituting context 224.15-013 (fig. 3). In the space enclosed by the wall, i.e. the structure's 'interior', two floor levels were again identified. The upper floor, 224.15-006, abuts the brick wall (fig. 3). It is also present west of the brick structure, near wall 224/N, but is obscured towards the south (figs. 2-3). It draws over the upper edge of the foundation course of wall 224/N and shows traces of localised burning (figs. 2-3: 224.15-035, 036). The lower floor, 224.15-009 (figs. 2-3), also shows traces of burning in the plane (224.15-037). The brick wall was founded on it. Floor 224.15-009 is obscured towards the north, but does not seem to abut the foundation of wall 224/N. A charcoal sample from this horizon gave a surprisingly early date:

Poz-73424 (Musa15 224.15-009-005): 2190 ± 30 BP
 68.2% probability
 356BC (46.3%) 286BC
 234BC (21.9%) 199BC
 95.4% probability
 361BC (95.4%) 178BC

South of the brick structure, the lowest layers connected to the deposit (224.15-023, -024) sit on a stratum of medium compact silty-sandy sediment (224.15-025), which resembles the natural ground i.e. the wadi sediment, but contains finds, namely sandstone fragments, few pottery, animal bones and charcoal (figs. 2-4, colour figs. 5-6). In its composition, it is very similar to the material of the brick wall collapse (224.15-013). It is also very similar to context 224.15-020, which seems to feature a higher concentration of finds in the southwestern corner of the trench (fig. 3), suggesting a layer boundary, but could otherwise be identical (figs. 2-4, colour figs. 5-6). Several small pits were dug into this/these layer(s), namely 224.15-010, -014, -030 and -031, which is partly cut by the former. The two pits close to wall 224/N (figs. 2-4: 224.15-010, -014, colour figs. 5-6) contained massive amounts of charcoal and seem to represent fireplaces, while the larger, irregularly shaped pits further south (figs. 2-4: 224.15-030, -031) also produced potsherds and animal bones. 14C dates have been obtained from charcoal from two of these pits:

¹⁷ Näser and Wetendorf 2014: 75.

**Poz-73425 (Musa15 224.15-010-003): 2155 ± 30 BP**

68.2% probability

351BC (29.5%) 303BC

210BC (36.2%) 164BC

128BC (2.5%) 121BC

95.4% probability

357BC (35.4%) 282BC

258BC (1.3%) 245BC

236BC (58.7%) 95BC**Poz-73436 (Musa15 224.15-030-003): 2120 ± 30 BP**

68.2% probability

196BC (68.2%) 106BC

95.4% probability

345BC (4.2%) 322BC

206BC (91.2%) 50BC

The enclosure wall 224/N seems to have its foundations in layer 224.15-020 (figs. 2–4, colour figs. 5–6). Context 224.15-034, which is only recognised in the western section (fig. 2, colour fig. 5), could be the refilled foundation trench.

Underneath contexts 224.15-020/025, the natural ground (225.15-021) is reached (figs. 2–4, colour figs. 5–6). The elsewhere typical leached horizon could only be observed in the southern part of the trench (figs. 2–3: 224.15-028). A shallow pit (figs. 2, 4: 224.15-026), which was dug into this horizon, probably represents a fireplace. Furthermore, two postholes, both of 16cm diameter, and 25cm respectively 33cm depth, positioned about 1m apart from each other, were observed in the northern part of the trench (224.15-011, -012). A charcoal sample from the pit gives the earliest date in the sequence:

Poz-73427 (Musa15 224.15-026-001): 2235 ± 30 BP

68.2% probability

374BC (13.8%) 352BC

297BC (48.6%) 228BC

221BC (5.8%) 211BC

95.4% probability

388BC (22.7%) 342BC

326BC (72.7%) 204BC

In sum, we can differentiate ten occupational events or phases:

- a first phase of use associated with pit 224.15-026
- the accumulation of the silty-sandy layer 224.15-020/025
- the construction of the enclosure wall 224/N, which according to Hintze is of the 6th building period¹⁸

- the digging of pits 224.15-010, -014, -030 and -031 into layer(s) 224.15-020/025
- the construction or accumulation of floor 224.15-009
- the construction of the mudbrick structure 224.15-007 and its use, including the construction or accumulation of the second floor 224.15-006; both floors show localised burning in the ‘interior’ of the brick structure
- the destruction and possible demolition of the brick structure and the deposition of its collapsed material (224.15-013)
- the generation of the lowest part of the deposit, consisting of layers 224.15-024, -023, -008 and -033
- the generation of the main deposit (224.15-002, -004, -005, -015, -022), possibly in a series of discrete events
- the abandoning of the area and the subsequent accumulation of the topmost layers of sand (224.15-027, -001), partly mixed with finds and disturbed by later interventions evident in contexts 224.15-016, -017 and -018.

This sequence refines the stratigraphic record from trenches 224.12 and 224.14,¹⁹ particularly with regard to the early occupation history of the area. The earliest evidence in the shape of a small fireplace dates from the 4th or 3rd century BC. Rather unexpected is the similarly early date associated with the ‘first’ floor 224.15-009 upon which the mudbrick structure had (later?) been built. The ‘main’ deposit shows more internal structuration than in the trenches further east, with several well defined layers at the bottom probably representing discrete dumping episodes. Two 14C dates from these layers, ranging from the later 1st to the 2nd century AD, are controversial. They may either indicate a ‘late’ date for the main deposit after the mid-1st century AD or a secondary deposition of the contexts on top of them.

THE POTTERY

The current excavation of trench 224.15 produced another 14,000 sherds with a total weight of c. 500kg. Less than 6% of these sherds are fineware pottery and only 0.55% of the whole corpus is handmade coarse ware pottery (table 1). The total number of sherds is surprising as the depth of the deposit diminishes towards the southwest, so that one might expect

¹⁸ Hintze and Hintze 1970: sketch 4.

¹⁹ See Edwards and Onasch in Edwards 1999: 8–11, Onasch 2004: 66–68, and Näser and Wetendorf 2014: 74–79.

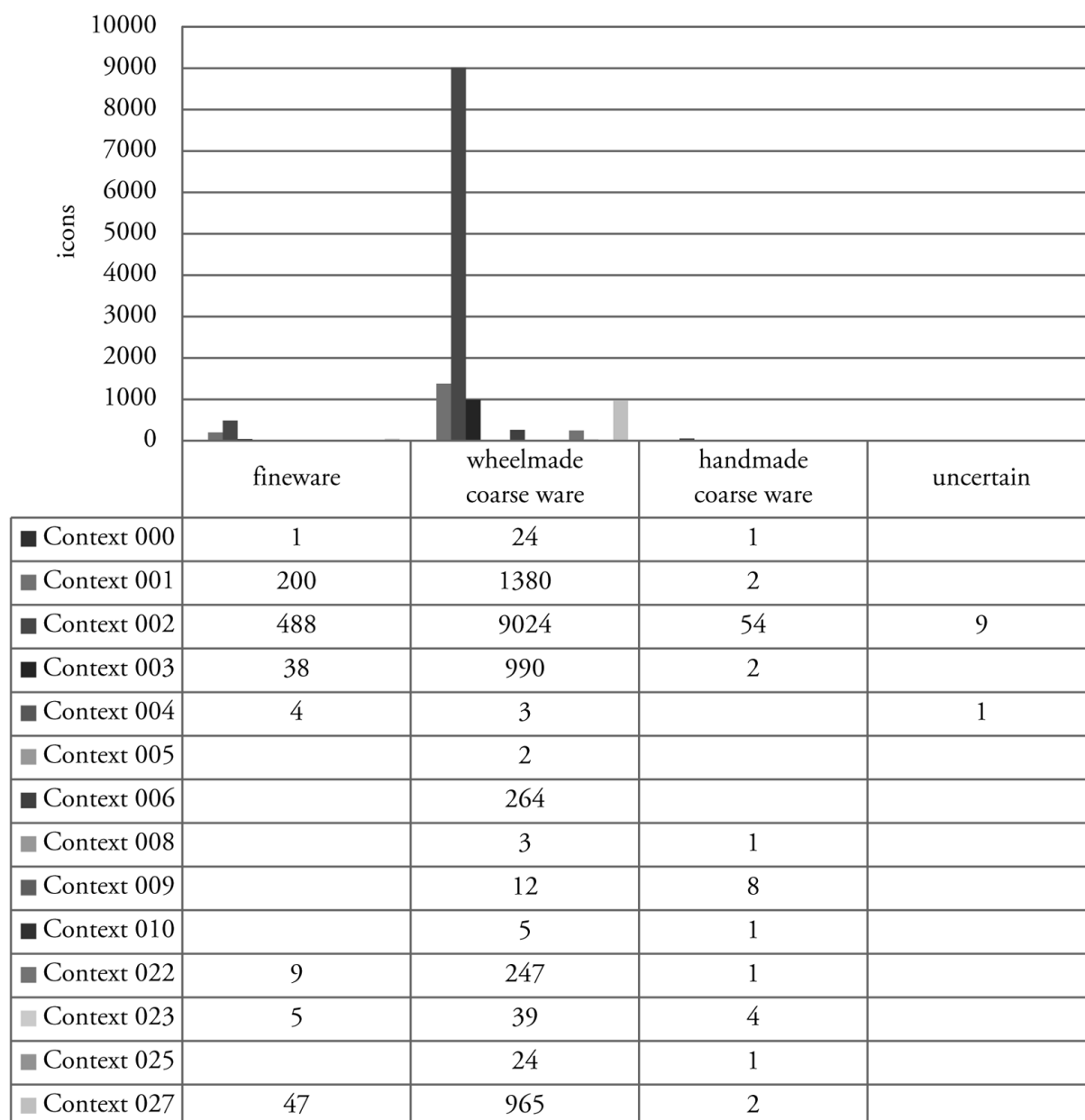


Table 1: Distribution of ware groups within the stratigraphic contexts of trench 224.15; N=13861, representing the material analysed to date from the 2015 excavations (statistics: Manja Wetendorf)

fewer finds per excavated square meter – which is not the case. As the find material from the bulk between the two excavation units of trench 224.15 which was only removed in the last days of the excavation could not yet be included in the statistics, the total number of sherds can be calculated at 14,000/8m² i.e. 1750 sherds per square meter.

All diagnostic sherds i.e. rims, bottoms and decorated fragments above a size of 1cm² were recorded in a database. All coarse ware diagnostic sherds were then analysed by fabric. The analysis of the fineware fabrics is ongoing. The altogether c. 12,000 undiagnostic coarse ware sherds were counted and weighted. Their total weight is 460kg. The 2000

diagnostic sherds make up an additional weight of c. 40kg. While the material from the bulk has not yet been analysed in detail, it was weighed and amounts to 173kg.

The degree of fragmentation of the pottery is nearly the same as in the 2014 material from neighboring trench 224.14. The same is true for the limited range of shapes among both finewares and coarse wares.²⁰ In contrast to the 2014 material, several near-complete vessels could be reconstructed, namely a

²⁰ Näser and Wetendorf 2014: 79; cf. Otto 1967: 29 and Edwards 1999: 16–17.

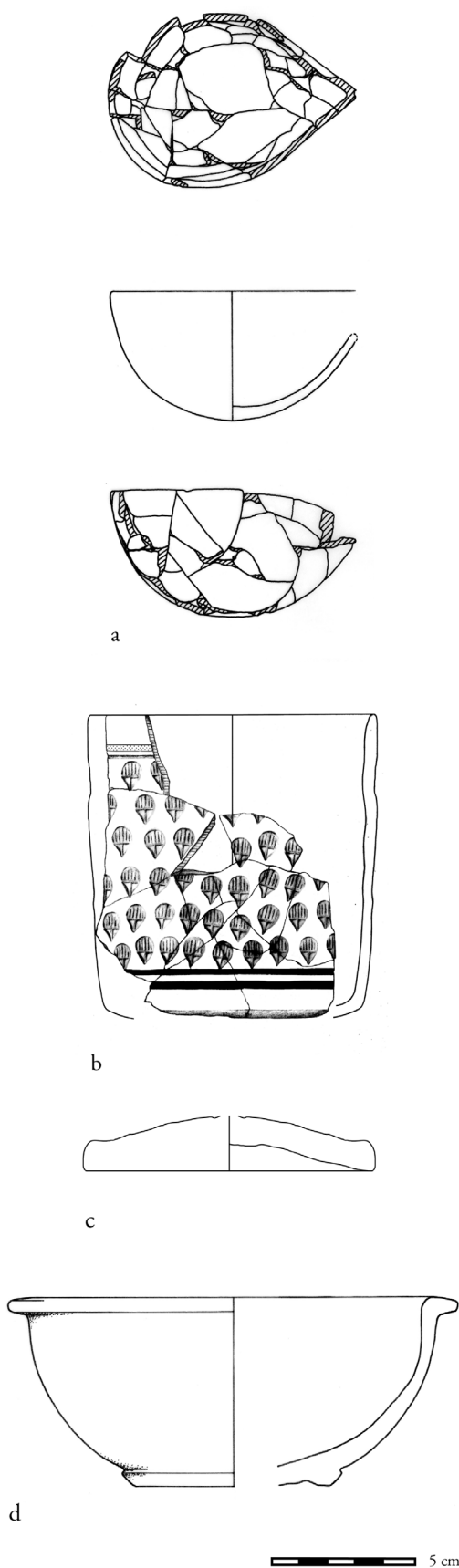


Fig. 6: Examples of complete and nearly complete vessels from trench 224.15 (drawings: Stephanie Bruck, Jaroslav Halik; graphic implementation: Manja Wetendorf)

bowl, a cup,²¹ a few small dishes or lids and a feeding cup (fig. 6a–d).

The distribution analysis within the stratigraphic contexts of trench 224.15 (table 1) indicates that the vast majority of the pottery comes from the main deposit 224.15-002, followed by the two topmost sandy layers, 224.15-001 and -027.²² Substantial numbers of wheelmade coarse ware pottery also derive from context 224.15-022, a lens of clay material at the bottom of the main deposit, and from the upper floor 224.15-006. In contexts where fineware is present, the ratio of fine and coarse wares is between 1:7 and 1:25, with the exception of the statistically insignificant context 224.15-004. The complete absence of fineware material from both floors, 224.15-006 and -009, as well as from the early context 224.15-025 is noteworthy. The lower floor 224.15-009 shows the highest ratio of handmade pottery.

Excavation of the main deposit 224.15-002 was carried out in three artificial layers of c. 15–20cm depth each. In the northern square, where the deposit was up to 75cm deep, a fourth artificial layer was excavated. The distribution analysis of ware groups within the main deposit 224.15-002 showed that the first removal produced the vast majority of pottery – both finewares and coarse wares – while the total counts, as well as the percentage, of finewares evenly diminished in the subsequent removals – with one exception: in the fourth removal the percentage of finewares (4.6%) is larger than in the third removal (3.5%). In contrast to the findings in trench 224.14, handmade coarse ware sherds do not derive exclusively from the lowest layers of the deposit, but were also present in the first and second removals (table 2).²³

Forms and decorations

The focus of the following section will be less on a comprehensive and detailed description of pottery forms and decorative motifs already known from

21 While the bottom of this piece is incomplete, it can still be compared to a specimen from the 1997 excavation which is very similar both in shape and decoration; see Edwards 1999: pl. XI, 853.

22 Context 224.15-003, which is fourth in the distribution, designates the refill of a sondage in the southeast part of trench 224.15 which had been (pre)excavated in autumn 2014 in order to obtain samples from the sediment of the main deposit for analysis in Berlin. The pottery listed under this designation can stratigraphically be attributed to contexts 224.15-001, -027 and the first removal of context 224.15-002.

23 This statistic of handmade coarse wares is based on diagnostic material recorded in the database and small fragments recorded in an excel list only.

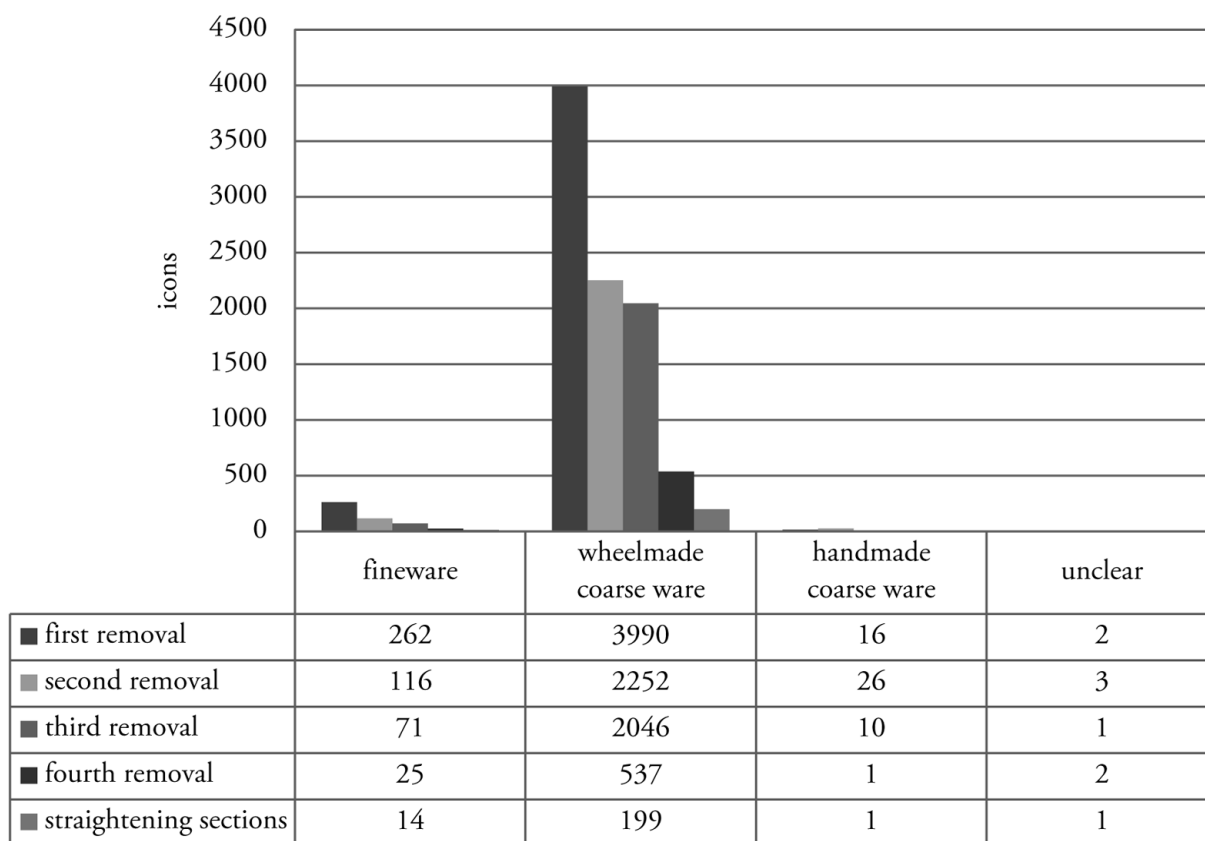


Table 2: Distribution of ware groups within context 002 of trench 224.15; N=9575, representing the material analysed to date from the 2015 excavations (statistics: Manja Wetendorf)

the deposit,²⁴ but more on shapes and decorative motifs recorded for the first time in the material of the present excavation as well as on their distribution within the contexts recorded in trench 224.15.

Finewares

Fineware pottery, comprising some 800 sherds, constitute only about 5.7% of the corpus, while they were more than two times as frequent (12.35%) in the 2014 material. They occur mainly as decorated wall fragments. Bowls again constitute the most frequent form group, while only a few cups and small bottles could be identified. The singular specimen of a small feeding cup has been reassembled from more than 30 tiny fragments (fig. 6a).²⁵ Most fineware sherds have slipped surfaces with colours varying from white to cream and from a light pink to red; few vessels have an orange to orange-red slip. In contrast to 2014, no yellow slipped vessels could be recognised.²⁶ The

white and red slipped specimens seem to be evenly distributed throughout the deposit and also occur in the layers above the deposit (224.15-001, -027) as well as in two packages of clay which form part of the deposit (224.15-004, -022). The rarer light pink and cream slipped sherds derive from the upper parts of the deposit and the topmost layer of windblown sand (224.15-001); but at least one light pink slipped sherd was also recovered from layer 224.15-022. In contrast to the distribution recorded in 224.14, the orange to orange-red slipped vessels appear both in the topmost layer of windblown sand 224.15-001, in 224.15-004 and in all layers of the main deposit, with the exception of the fourth removal. Fineware pottery is often polished, especially when it is slipped.

Contrary to the 2014 corpus, stamped decoration is not restricted to bowls in the current material. It also occurs on cups and at least one bottle fragment. While the stamped decoration on bowls is mainly restricted to the upper third of the vessel (fig. 9b, d), the decoration on cups extends closer towards the bottom (fig. 6b).²⁷ Commonly, stamped decoration

24 See Näser and Wetendorf 2014: 80–83 and Edwards 1999: 14–41, 79–99.

25 Similar feeding cups are known from Meroe, e.g. Shinnie and Bradley 1980: fig. 28, 7.

26 Sometimes the combination of a white slip and a red painted decoration causes a light orange to yellowish colour at their point of contact, in few cases this colouring

also extends onto larger areas of the slip – which is mainly due to production process (firing) and not intentional.

27 Cf. Edwards 1999: pls. X–XI and Seiler 1999: 63 for the operational procedure of stamped decoration.



appears in combination with painted decoration – usually in the form of single or double lines, at least once with a floral painting on the upper interior of a bowl – and even incised lines bordering the stamped area. Usually, there is only one stamp motif per vessel.²⁸ The combination of two different stamp motifs, painted decoration and incised lines is recorded only once, on a bottle of which several non-joining body sherds have been preserved (fig. 9a). The shoulder area carries a single row of a rhomboid stamp motif, framed by two dark red-brown lines and two straight incised lines. Underneath this band, a decoration of a vertically arranged slip knot stamp motif seems to completely cover the lower part of the bottle.²⁹ Only the lower part of the body, underneath the stamped and painted band is white slipped, the upper part – as far as it is preserved – is painted in red. Stamped decoration commonly occurs on vessels with a white to cream or light pink slip or on unslipped vessels. A few red slipped bowls with stamped decoration were also recorded (fig. 9c).³⁰ Some new stamp motifs can be added to the 2014 series and Edwards' previous corpus, including several simple geometric (e.g. rhombs) and floral forms (e.g. simple flowers) and, as a highlight, a frog sitting on a lotus flower³¹ (fig. 9e).

Painted decoration occurs on all vessel forms present in the corpus, with the single exception of the feeding cup, which is undecorated. Motifs are frequently framed by lines – mostly single or double. Floral motifs are very common on bowls and bottles. They include trefoils, wine leaves, simple flowers arranged in horizontal rows and papyrus flowers (fig. 10b, e). Some other designs have only tentatively been identified as floral motifs. Geometric patterns are common on bowls and cups. They comprise the chess board motif, bands of triangles and rectangles arranged in lines,³² simple cross patterns and drop shaped motifs or simple bands framed by, usually, two lines (fig. 10c, f). The so-called guilloche motif occurs only on bowls (fig. 10d).³³ No human or ani-

mal motif was recorded in the current material. Few bottles have painted *ankh*-signs on their shoulders. Motifs and bordering lines are usually painted in a dark red-brown colour, sometimes several zones are filled with red colour.³⁴ Painted vessels usually have a white slip or are unslipped. Only a few bowls with geometric motifs have a red slip (fig. 10a). A red rim band is very common among stamped as well as painted vessels. Surfaces can be polished, especially when they are slipped.

Painted and stamped fineware pottery generally occurs in all layers of the main deposit 224.15-002, but is most frequent in the upper two removals as well as in layers 224.15-027 and 224.15-001 above the main deposit. Fragments of painted fineware pottery are also present in the clay packing 224.15-022. Finally, two fragments of painted bottles come from the clay packing 224.15-004 in the lower part of the deposit.

Generally, the shapes of fineware pottery and the associated decorative motifs are well-known from other Meroitic sites, while particular design arrangements also give the feeling of 'individual fingerprints'. The fineware pottery from Musawwarat was produced locally, using quite an extensive number of designs. The view of this decorative repertoire, representing a single production locus, again confirms that Upper Nubian stamped finewares are much more diversified than the specimens known from Lower Nubia.³⁵ Six new stamps were recovered during this season's excavations (figs. 13–14). Their designs do not, however, match any of the decorations actually preserved, with the possible exception of the uraeus with sun disc motif which occurs on a very small sherd from trench 224.14 (fig. 7).

Wheelmade coarse wares

The vast majority of the material – roughly 13.000 sherds – is made up of wheelmade coarse ware. Again the most common shapes are different types of bowls and dishes, jars and bottles as well as few lids or small dishes.³⁶ A small number of offering stands can be

28 Dito Edwards 1999: 30, note 15.

29 Other rare examples of combined stamp motifs on an individual vessel are known from Qustul and Ballana, Meroe and Gabati; Williams 1991: figs. 166.b, 290.b; Török 1997: e.g. figs. 87 <197-95>, <289-9>, 115 <908-1>, pl. 223 <x-ss>; Rose 1998: 162, fig. 6.16 <9403>.

30 Cf. Edwards 1999: 31 with further references.

31 Frog stamps are listed e.g. in the Meroe material, cf. Török 1997: e.g. fig. 98 <286/7-105>, and Shinnie and Bradley 1980: fig. 56 a, but without lotus leaf.

32 For a similar pattern e.g. on pottery from Gabati see Rose 1998: 162, fig. 6.16 <515>.

33 Edwards 1999: 32 noted that this motif is comparatively rare in Meroitic contexts, but not confined to Meroe. For examples from there see Török 1997: fig. 93 <286/7-49>. For examples from Abu Geili and Gebel Barkal see Craw-

ford and Addison 1951: pl. XL,6 and Bąkowska 2010: 194, fig. 5.59.

34 The colour used for painting finewares is described as dark red, dark red-brown or even black, and more variations within this range, in different publications, but might in fact be the same, with variations being caused when the colour is of varying texture or is applied in varying thickness.

35 See, e.g. Shinnie and Bradley 1980: figs. 53–57; Török 1997: e.g. figs. 86, 98, 104 and Dittrich 2003: fig. 7 in comparison to Williams 1991: 59–60, table 9.

36 For a more detailed description of the various shapes see Näser and Wetendorf 2014: 80–82.

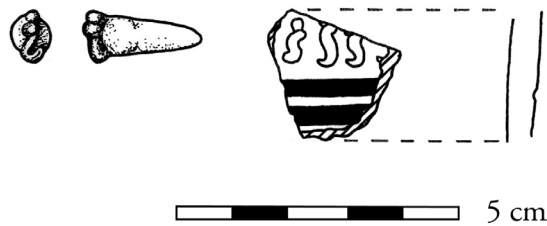


Fig. 7: Potter's stamp with a uraeus with sun disc motif (IA-224.15-002-065), probably matching the stamped decoration on a fineware sherd (IA-224.14-001-002_VU038) (drawings: Stephanie Bruck, Jaroslav Halik; graphic implementation: Manja Wetendorf)

added to the repertoire (fig. 8b–c).³⁷ Round and conical bottoms are the most common vessel bases and can probably be associated with different forms of jars (e.g. beer and storage jars³⁸) and several forms of bowls (e.g. conical bowls³⁹; fig. 11d–f). A small number of flat and ring bases also occur in the material and belong potentially to several groups of bowls and jars (fig. 11g). Ring bases are also associated with small ledged rim bowls, of which one example could be completely reconstructed (fig. 6d).⁴⁰ The shape of a pointed base is reminiscent of bread moulds, but could also be the cone end of an amphora (fig. 8a).⁴¹ A few fragments of handles also occur in the current material and probably point to amphorae.

The dominant colour of slipped vessels is red, with some showing a more orange tint. Only a very few sherds have a white to cream slip.⁴² On some examples, the slip occurs together with a burnish or polish. Two different types of decoration, incised and painted, occur on the wheelmade coarse wares, with incisions dominating. Painted decorations mainly consist of bands on shoulders of beer jars and bottles.⁴³ At least one neck of a beer jar is decorated with

37 They appear to be similar to offering stands recovered from 224.12; see Edwards 1999: pl. IX, 778, 777, 785. Cf. also Seiler 1999: figs. 51, a.1–c.1, 52.

38 See, e.g. Edwards 1999: 79–82, pls. I–IV.

39 See, e.g. Bąkowska 2010: 194, figs. 5, 58; Gerullat 2001: 72. a–d.

40 Cf. also Edwards 1999: 86, e.g. 732. This vessel type is also common on other Meroitic sites, e.g. Gabati and Meroe; cf. Rose 1998: 159, fig. 6.13 <4010>, <4011> and Shinnie and Bradley 1980: e.g. 101, figs. 31, 43.

41 The presence of bread moulds would not surprise as they are used for special occasions; but as none was found till now it seem to be implausible to identify this bottom to be part of a bread mould. Maybe this fragment belong to an amphora, cf. Otto 1967: 27, fig. 18. XI, b 3.

42 Cf. Edwards 1999: 79, pl. I, 718.

43 For more detailed description of the design see Näser and Wetendorf 2014: 81. It should be noted that dark red-brown lines can be painted on white bands, or lines

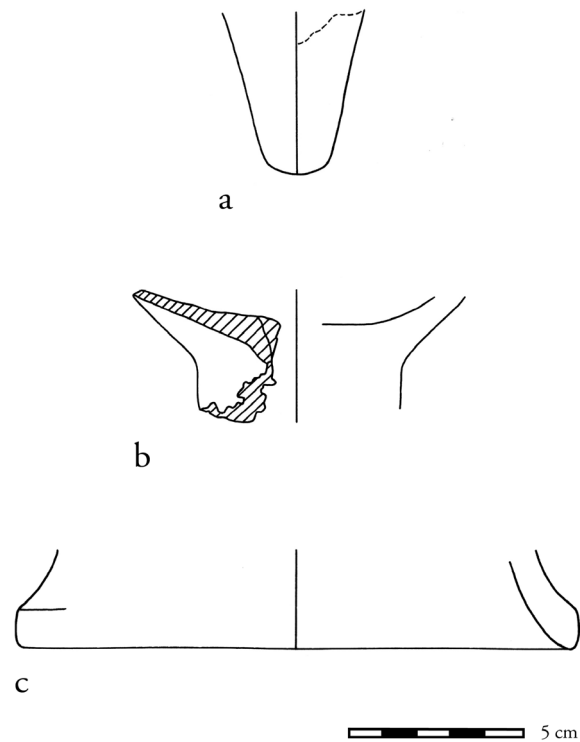


Fig. 8: a) probable amphora base; b–c) vessel fragments identified as parts of offering stands (drawings: Stephanie Bruck, Jaroslav Halik; graphic implementation: Manja Wetendorf)

a dark red-brown band and a white topping. Several sherds of a red slipped polished bottle or beer jar are decorated with an *ankh*-on-crescent design (fig. 11a).⁴⁴ As in the 2014 material, incised decorations occur as simple bounded lines near the rim on the interior and/or the exterior of bowls with sloping sides of different sizes as well as on smaller-sized bowls with flat rims (fig. 11c). Shallow bowls or open dishes with slightly flaring and square-edged rims frequently show one or several bounded lines on their interior.⁴⁵ Incised wavy lines framed by a band of one or several lines are associated with large open jars with mostly squared rims (fig. 11b).⁴⁶ Jars with recessed rims and dishes with incurved rims as well closed jars are mostly undecorated.

are painted first and the space between them was filled in white later – both variants are present in the current material.

44 For the decorated neck of a beer jar cf. Edwards 1999: 82, pl. IV, 771, for the *ankh*-on-crescent design cf. Edwards 1999: 81, pl. III, 793.

45 Cf. Edwards 1999: 83, pl. V, e.g. 748, 782.

46 Cf. Otto 1967: 28, type XII, fig. 19; Edwards 1999: 79–80, pls. I–II; Seiler 1999: figs. 45, 4.1.4, a.1–a.3; Gerullat 2001: 75, 'Böttiche' fig. c. For examples from other sites see e.g. Dittrich 2003: 83, fig. 4.6 and Bąkowska 2010: 194, fig. 5.51 for a similar shape.

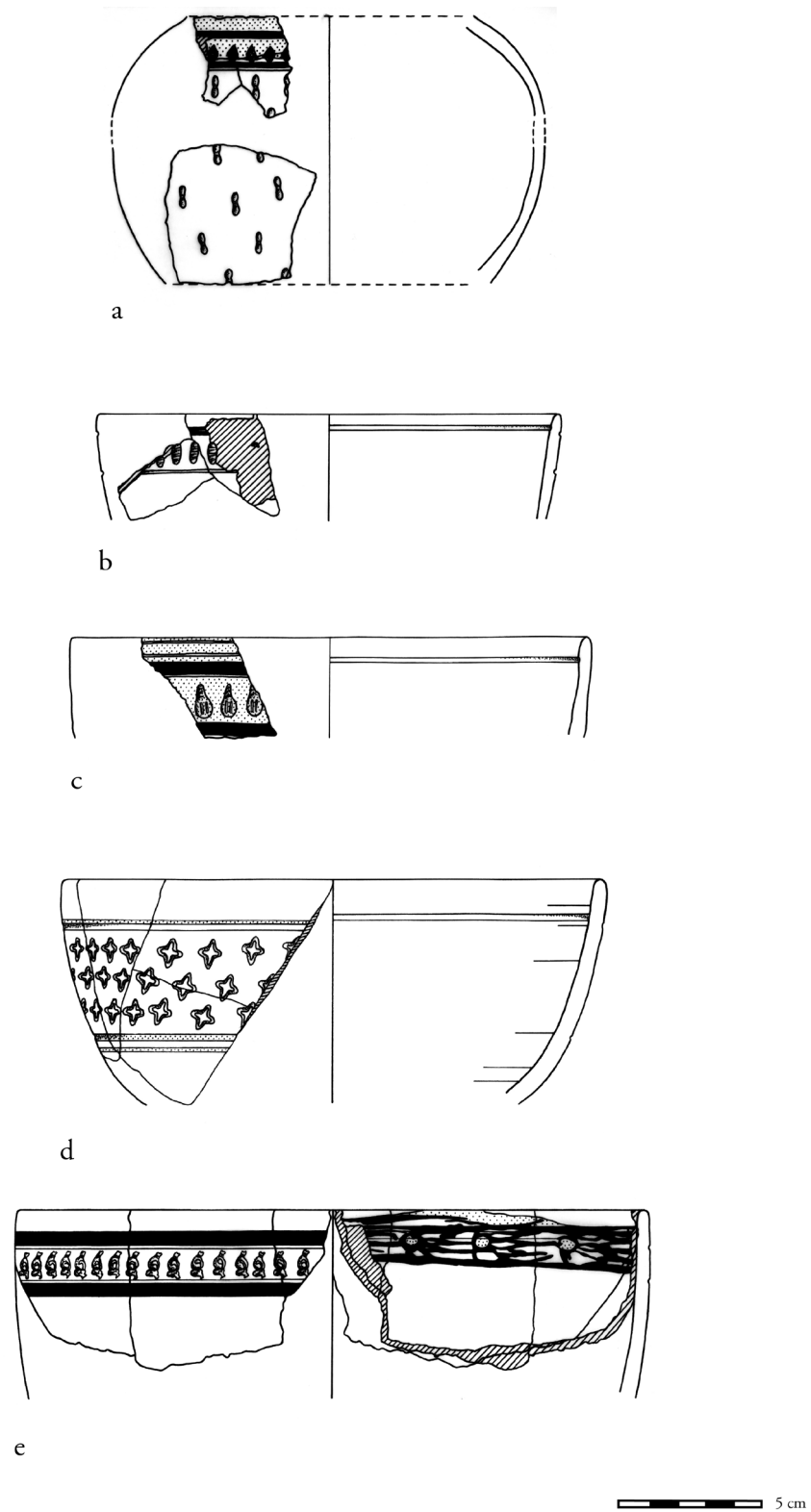


Fig. 9: Examples of stamped decoration on finewares (drawings: Stephanie Bruck, Jaroslav Halik; graphic implementation: Manja Wetendorf)

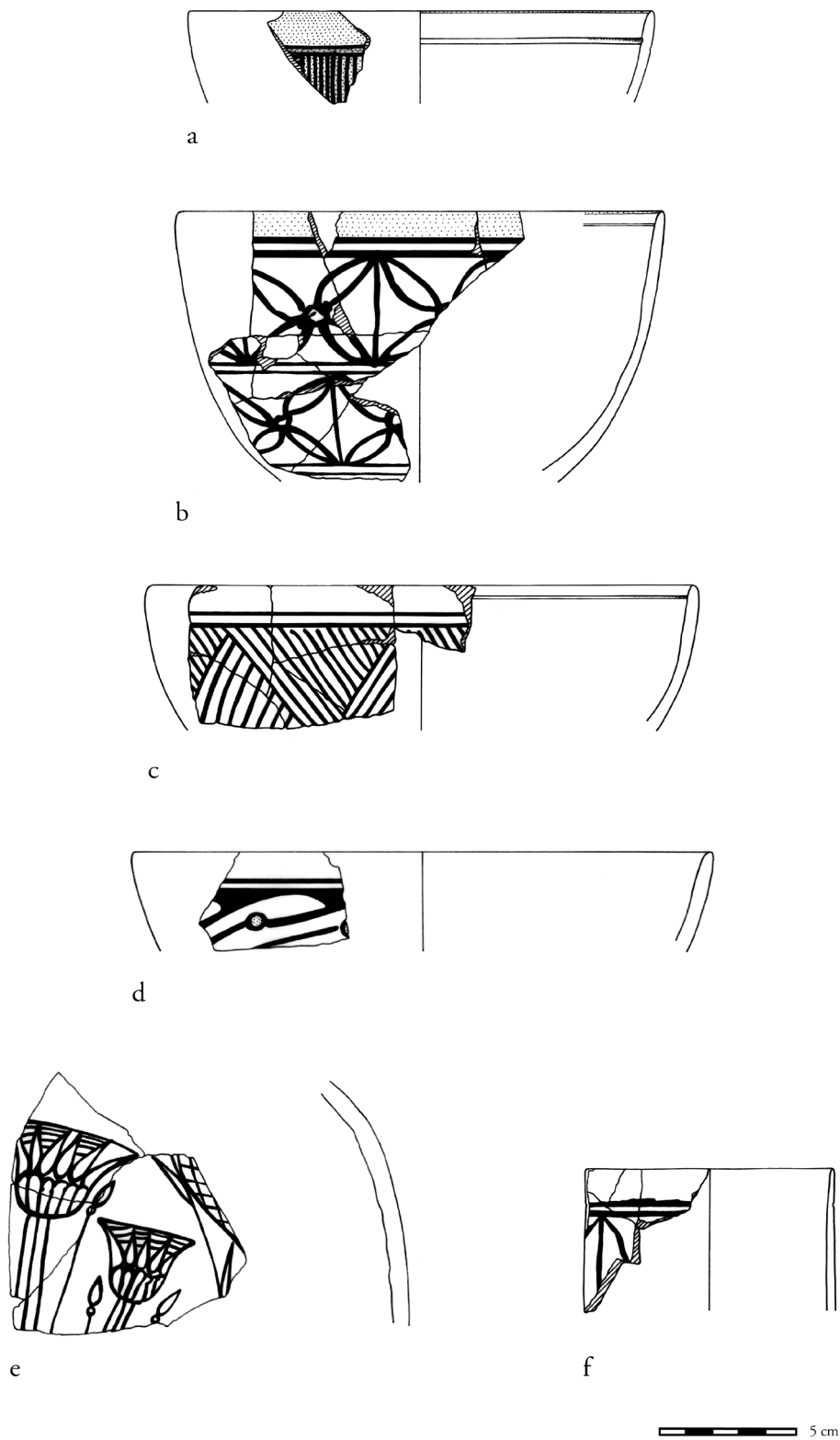


Fig. 10: Examples of painted decoration on finewares (drawings: Stephanie Bruck, Jaroslav Halik; graphic implementation: Manja Wetendorf)

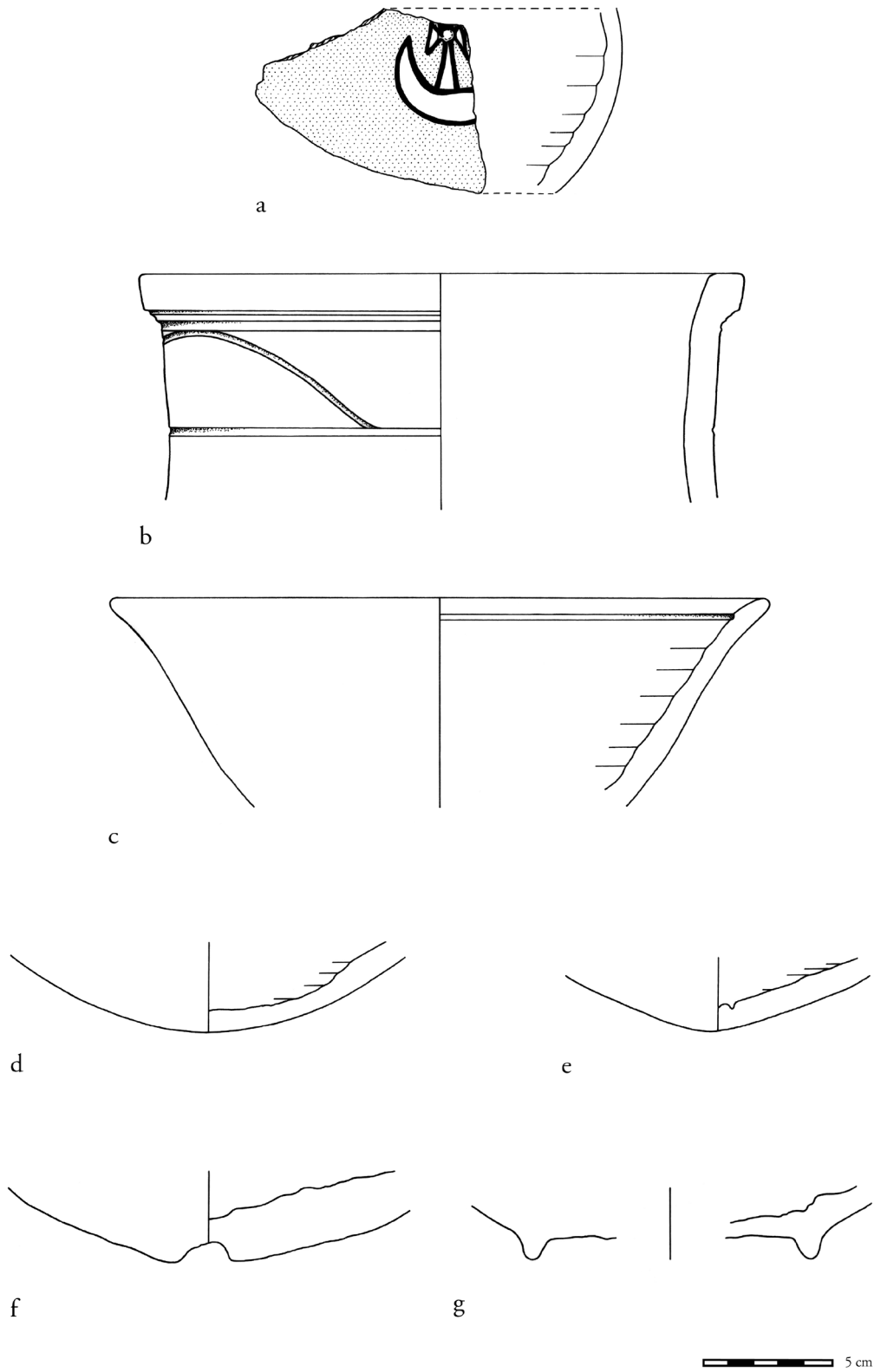


Fig. 11: Examples of wheelmade coarse ware shapes and types of decoration (drawings: Stephanie Bruck, Jaroslav Halik; graphic implementation: Manja Wetendorf)

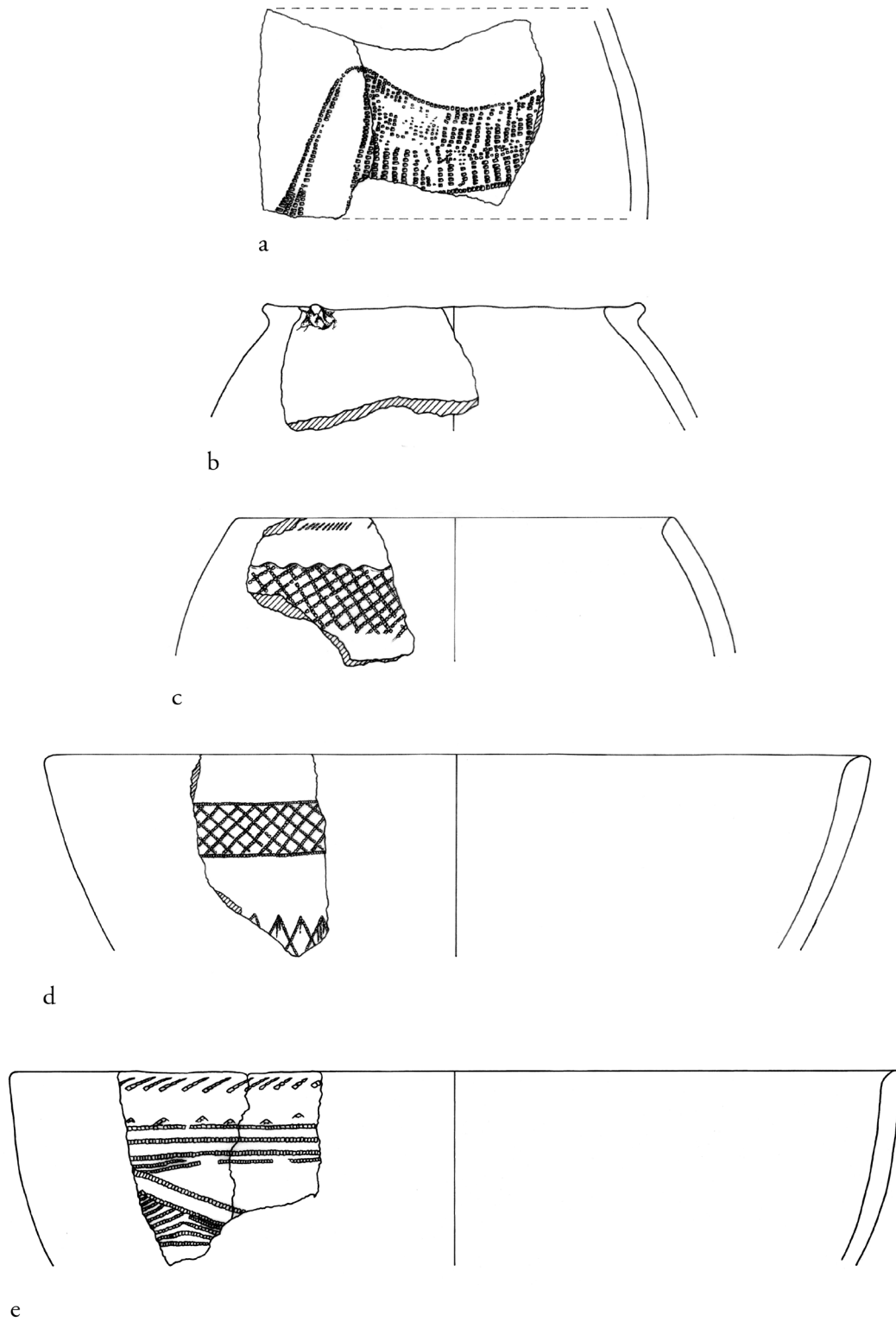


Fig. 12: Examples of handmade coarse ware shapes and types of decoration (drawings: Stephanie Bruck, Jaroslav Halik; graphic implementation: Manja Wetendorf)

Vessels with incised decoration occur in all layers of the deposit 224.15-002 as well as in the topmost layers above it (224.15-001, -027) although wavy-line decorated jars are rare in the latter. Within the clay packages (224.15-005, -022), an accumulation of sherds with a red to dark red slip and a burnish or polish was identified. Two bowls which were partly reconstructed from sherds from context 224.15-005 have an incised decoration, while the pieces from context 224.15-022 probably belong to ledge-rimmed bowls.⁴⁷ Painted bottles occur in all layers of the main deposit 224.15-002, but are absent from other contexts. With only two rims of these bottles – both from the first removal of the deposit – preserved, chronological statements based on shapes are impossible. Wheelmade coarse wares from layers underneath the deposit are mostly undecorated wall fragments which do not allow the reconstruction of vessel shapes. The few shapes identified with a reasonable degree of certainty comprise an incised bowl with red-brown to orange slip from context 224.15-023 and a small red slipped bowl with a bounded incised line close to the rim on its interior from context 224.15-006.⁴⁸ Some wheelmade pottery showed burn marks which probably developed during the firing process.⁴⁹

Handmade coarse wares

As stated at the outset, handmade coarse ware amounts to only 0.55% of the whole corpus, as compared to 1.24% in the 2014 material. Vessel shapes are mainly open with a few closed bowls with plain rounded rims as well as closed jars with mostly plain rim. At least one jar featured a slight ledge rim with a small lug (fig. 12b). Surfaces are usually well smoothed or burnished to polished, rarely covered by a slip. Some burn marks were noted. A few pots are completely black which indicates that they were fired in a reduced atmosphere. Isolated sherds have an overfired surface. All of them, however, were tentatively classified as imports (table 3: categories 3, 4). This is important, as it shows that overfired sherds do not necessarily represent wasters.⁵⁰ Comb-impressed decoration is the common design on bowls, sometimes in combination with incised decoration. Some vessels preserve white col-

our in the individual impressions (fig. 12c). Motifs are mostly geometric designs, namely crossed dotted lines arranged in bands (fig. 12c–d) or dotted lines forming triangles (fig. 9d) as well as simple dotted lines underneath the rim (fig. 12c, e). In a very few cases, rim decoration proper was also noted. A singular motif is a comb-impressed animal, probably a cow (fig. 12a).⁵¹ Handmade coarse wares, whether they are decorated or not, occur in all layers of the main deposit and associated contexts (224.15-008, -022, -023). Isolated sherds also come from the layers above the deposit (224.15-001, -027) as well as from three earlier contexts, namely 224.15-009, -010 and -025. It is noteworthy that the percentage of handmade sherds from the contexts at the bottom of the deposit (224.15-008, -023) as well as from earlier strata (224.15-009, -010, -025) is higher than from the main deposit itself (table 1).⁵² Values range between 4% and 40% as compared to 0.56%.

Fabrics

The fabric analysis of the fineware pottery, based on the results of the initial archaeometric study of 2013⁵³, is ongoing. A first, disappointing result is that the different fabric groups defined in the archaeometric study range from difficult to impossible to distinguish macroscopically. This matter is made worse as vessel shapes, surface treatments and types of decoration also cannot be relied upon to provide safe indicators in this respect. Thus, analysis by microscope is required and new classification criteria need to be established – and eventually explained with regard to production processes, potters' choices etc. Generally, it is still safe to assume that almost all fineware fabrics in the present corpus represent local production; only a very few sherds must be addressed as imports.

The fabric analysis of the coarse wares is based on the results of the archaeometric study of 2014⁵⁴, which was conducted on 34 samples including wheelmade and handmade coarse ware pottery. Referring to these results, a new fabric system for coarse ware pottery was established which comprises four major categories which in turn include altogether

47 See, e.g. Edwards 1999: pl. VIII, 732–734; cf. Bąkowska 2010: 191, fig. 3.25–31.

48 For the latter, cf. Edwards 1999: 85, pl. VII, 775.

49 As no pottery kilns were identified up to now, burn marks could be seen as an additional indicator that vessels were fired in open bonfires.

50 It seems unlikely that wasters would have been brought to Musawwarat from elsewhere.

51 Cf. a probably similar motif on a sherd from Meroe and on a bowl from Gabati; Shinnie and Bradley 1980: 128, fig. 58.c; Rose 1998: 174, fig. 6.23 <3807>.

52 The statistical significance of this observation is limited first by the small overall number of handmade sherds and second by the fact that their number may somewhat disproportionately increase when the larger corpora of undiagnostic sherds, which have only been counted and weighted so far, will be subjected to a detailed study.

53 Näser and Daszkiewicz 2013: 15–22.

54 Daszkiewicz and Wetendorf 2014: 99–104.



	Mus4 (Fab001–006)	Category 2 (Fab007–013)	Category 3 (Fab014–017)	Category 4 (Fab018–021)	unclear
items	886	39	40	34	147

Table 3: Distribution of coarse ware pottery within the four major categories; N=1146, representing the diagnostic material analysed to date from the 2015 excavations (statistics: Manja Wetendorf)

Context	Mus4	Category 2	Category 3	Category 4
224.15-000	x	0	x	0
224.15-001	x	x	x	0
224.15-002	x	x	x	x
224.15-003	x	0	x	0
224.15-004	x	0	0	0
224.15-005	x	0	0	0
224.15-008	x	0	0	0
224.15-009	x	x	x	x
224.15-010	x	x	0	0
224.15-022	x	0	x	0
224.15-023	x	x	x	x
224.15-025	x	x	x	0
224.15-027	x	0	0	0

Table 4: Distribution of coarse ware pottery fabrics within stratigraphic contexts of trench 224.15; N=1146, x = group present, 0 = group absent (statistics: Manja Wetendorf)

21 fabric groups (table 3).⁵⁵ Pottery of the first category (reference group Mus4 = MGR group 102) is made from wadi clays and represents primarily local wheelmade production, but also includes a small number of handmade sherds. The vast majority of the analysed pottery from trench 224.15 belongs to this category, which comprises six fabric groups (Fab001–006). After observations in the field and the analysis of raw material samples from the vicinity of the site,⁵⁶ a particularly good match for this group is the clay from the basin of Hafir Khalifa in front of Gebel Maafer.⁵⁷ The second category (MGR groups 105, 110–111, 115–118) includes several wadi clays and comprises seven fabric groups (Fab007–013). Despite the fact that no match for these clays has yet been found in the raw material study, geochemical parameters indicate that they are also local or at least from the wider region of Musawwarat.⁵⁸ Handmade

pottery and a few wheelmade coarse wares belong to this category. The third category (MGR groups 106, 108–109) comprises imports of various Nile alluvial clays; so far four fabric groups (Fab014–017) have been identified. In the current material, this category is represented by handmade pottery, while the series analysed in 2014 also included one wheelmade sherd.⁵⁹ The fourth category (MGR groups 107, 112–114) comprises various imports of clays of different origins. It includes three fabric groups (Fab018–021) and is related to handmade pottery; in the series analysed in 2014 again one wheelmade sherd belonged to this group.⁶⁰

The preliminary distribution analysis shows that pottery from local wadi clays (category 1 = Mus004) occurs in all contexts of trench 224.15 (table 4). This indicates two things: firstly, a long tradition of using the same raw material sources for the production of ceramics, from as early as the 4th to 2nd centuries BC, and secondly, the long-standing local production of wheelmade ceramics, going back several centuries

55 A new series of samples has been submitted for analysis in order to confirm attributions within this system and to investigate whether 'uncertain' sherds belong to new fabric groups/sub-groups or not.

56 See Daszkiewicz and Wetendorf, forthcoming.

57 Cf. Daszkiewicz 2014: 99.

58 Cf. Daszkiewicz 2014: 102.

59 Daszkiewicz 2014: 102.

60 Daszkiewicz 2014: 100, table 1.



before the workshop in courtyard 224.⁶¹ As the pottery from the early contexts is often heavily fragmented and generally in a bad state of preservation, a shape typology is not available. Pottery of category 2, which comprises several as yet unprovenanced wadi clays from sources in Musawwarat or the wider region, seems to follow the same distribution pattern, as far as the limited number of sherds of this category justifies a statement. Pottery from Nile alluvial clays (category 3) is also present in almost all contexts which produced more than a minimum number of finds, with the inexplicable exception of context 224.15-027. Imported handmade pottery (categories 3 and 4) occurs in the deposit 224.15-002 as well as in the layers above. This indicates that vessels – or sherds – of this group have been discarded together with the other material in these contexts.

Summary

In sum, the ongoing fabric analysis has confirmed that the majority of the wheelmade coarse wares found in contexts of the ‘pottery courtyard’, as well as almost all finewares, are made from ceramic bodies of similar chemical and mineralogical composition, which are sourced from the same geological region and can be associated with local production at Musawwarat. In contrast, analysis indicated that the majority of the handmade pottery is of fabrics of non-local origin and, thus, must have been imported from elsewhere. The overall variety of vessel shapes is relatively limited. Individual vessel forms and decorative motifs are generally well-known from other sites and match the repertoire recorded from neighbouring trenches 224.12 and 224.14, with the addition of some new shapes, such as offering stands and a feeding cup, and new designs, such as a frog stamp and impressed figural motifs.

OTHER FINDS

While pottery constituted the vast majority of the finds from trench 224.15, other finds also deserve attention. Low quantities of mostly very fragmented animal bones were recovered from the topmost sand layers (224.15-001, -027), the main deposit and associated contexts (224.15-002, -005, -022, 023), floor 224.15-009, pits 224.15-010, -030 and -031, and the early silty-sandy layer 224.15-025.⁶² Several pieces

of slag, which are currently awaiting archaeometric analysis, derive from the main deposit 224.15-002.

The most noteworthy finds are six more stamps for decorating the typical Meroitic fineware pottery, among them a so far unique double-sided specimen (figs. 13–14).⁶³ All of the stamps are made of pottery. The four complete specimen measure between 2.15 and 3.0cm in length. Their motifs comprise two versions of the three-petal flower motif, a uraeus with sun disc and two versions of a rhomboid shape. One of the stamps was recovered from the topmost layer of windblown sand (224.15-001-004). Four came from the upper 20cm i.e. the first removal of the main deposit (224.15-002-065, -066, -082A, B); among these was one fragmentary piece (24.15-002-082B) and the double-sided specimen (24.15-002-082A). Another fragmentary specimen came from a clay lens near the bottom of the main deposit (224.15-022-005), indicating that this lens was also associated with pottery production.

A large amount of pottery production debris (fig. 15), mainly chunks of unfired clay which derive from the process of throwing the vessel on the wheel, comes from the main deposit⁶⁴, a clay lens within the deposit (224.15-022-001, -006) and the lower floor (224.15-009-006). The material from the latter findspot needs to be rechecked for correct identification. While all the material will need to be studied in detail with regard to the information it holds about the process of pottery production, a first sorting has already produced fragments with mat impressions (224.15-002-044, -022-006; fig. 15) as well as pieces which may show secondary burning (224.15-002-003, -089). Fragments of unfired pots were recorded from two clay lenses within the main deposit (224.15-005-004, 224.15-022-007). Two other objects have the shape of plugs. One of them is of unfired clay (fig. 16: 224.15-002-097), while the other seems to have experienced secondary firing at a low temperature (224.15-022-008). They could represent jar stoppers or could have been related to the process of pottery production.

Another find group is implements of stone and, more rarely, pottery which may also have been connected to pottery production, though this is not easy to ascertain in most cases. One of these objects is merely a small unusually shaped sandstone fragment (224.15-001-008). Others are proper rubber (224.15-

61 For the dating of the archaeological contexts see above, p. 39–40.

62 The analysis of this material is ongoing.

63 For similar stamps from the previous trenches see Edwards 1999: 12–13, fig. 12, pls. 1.5–6, 2.7, and Näser and Wetendorf 2014: 83, fig. 24.

64 224.15-002-003, -008, -016, -025, -035, -044, -050, -060, -062, -070, -073, -080, -088, -089, -093.

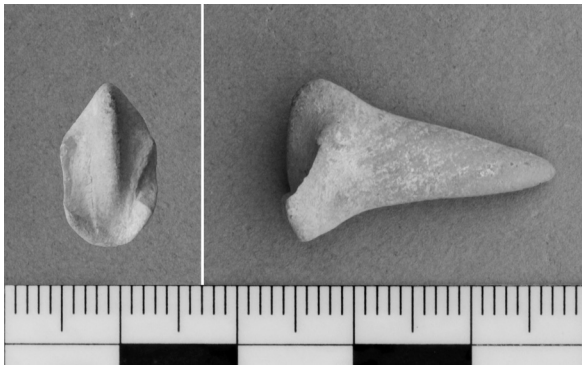


Fig. 13: Potter's stamp, 224.15-001-004 (photo: Jürgen Dombrowski)

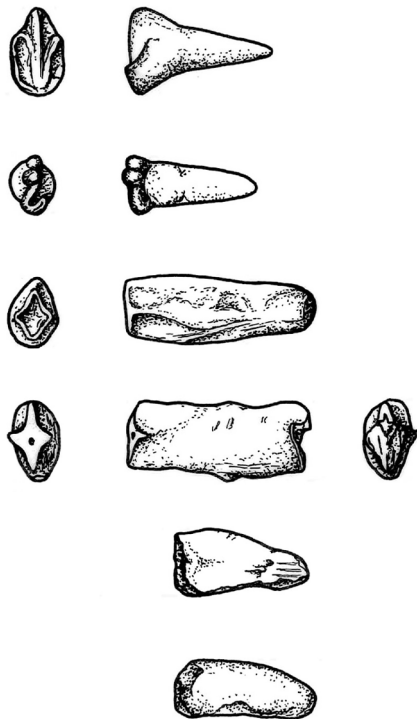


Fig. 14: Six potter's stamps from the current excavations, 224.15-001-004, 224.15-002-065, -066, -082A, B and 224.15-022-005 (drawings: Stephanie Bruck, Jaroslav Halik; graphic implementation: Manja Wetendorf)

002-084, -094) and grindstones (224.15-000-004⁶⁵). Two small, roughly triangular implements, with maximum extensions of 3.4 and 2.8cm respectively,

⁶⁵ This context designation signifies that the find could not be assigned to a clear stratigraphic context in the process of excavation. After the complete analysis of the stratigraphic data, it can be associated with either context 224.15-023 or -024.

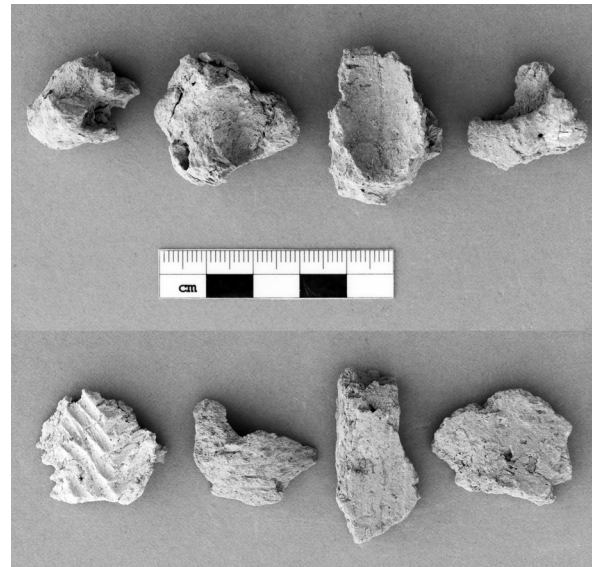


Fig. 15: Pottery production debris, top: 224.15-002-008, bottom 224.15-002-044 (photo: Jürgen Dombrowski)



Fig. 16: Plug-shaped object of unfired clay, 224.15-002-097 (photo: Claudia Näser)

show clear traces of use as polishing stones (fig. 17: 224.15-022-009A, B). A slightly smaller, fragmentarily preserved pebble may have had a similar function (224.15-002-083). Another massive stone implement with a polished surface and a suspicious notch came from the fill of one of the 'early' pits (fig. 18: 224.15-030-004). One fragment has a corroded hole and was first thought to represent the fragment of a turning device (fig. 19: 224.15-002-037). However, the uneven, unsmoothed surface of the hole's interior speaks against this theory, and the dark red crust in the same place rather suggests the impact of heat. Two plate-like fragmentary sandstone slabs were suggested to have been working platforms (224.15-005-005, 224.15-000-009⁶⁶). One pottery object may

⁶⁶ According to the post-excavation analysis, the find context of this piece was either 224.15-005, -022 or -023.

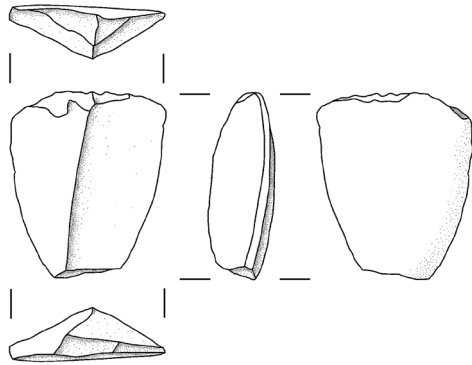


Fig. 19: Stone fragment with a corroded hole, 224.15-002-037 (photo: Jürgen Dombrowski)

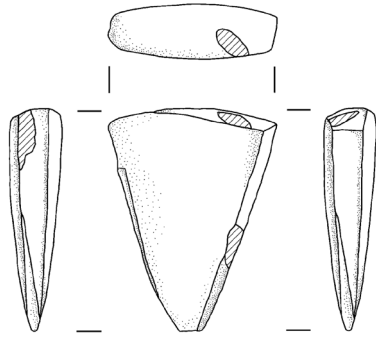


Fig. 17: Polishing stones from a lens of clay material in the lower part of the deposit, 224.15-022-009A, B (drawing: Claudia Näser; graphic implementation: Kateryna Kortschagina, Kay Kossatz)



Fig. 18: Stone implement from an early occupation context, 224.15-030-004 (photo: Claudia Näser)



Fig. 20: A tentatively identified turning platform, 224.15-002-031 (photo: Jürgen Dombrowski)

represent a turning platform (fig. 20: 224.15-002-031), a device which in German potters' terminology is called 'Abdrehstößel'.

Small pottery balls were found repeatedly (224.15-002-012, -039, -055B, 224.15-027-005; fig. 21). Their diameters range from 0.7 to 0.85cm, with only one exception of 1.2cm (224.15-027-005). A more ovoid pottery object, of slightly larger dimensions, with a maximum extension of 2.45cm was also found (224.15-002-017). There is also a range of unfired clay balls (224.15-002-054B, 224.15-022-



Fig. 21: Pottery 'barrel' and balls, 224.15-002-055A, -012, -039, -055B (photo: Jürgen Dombrowski)

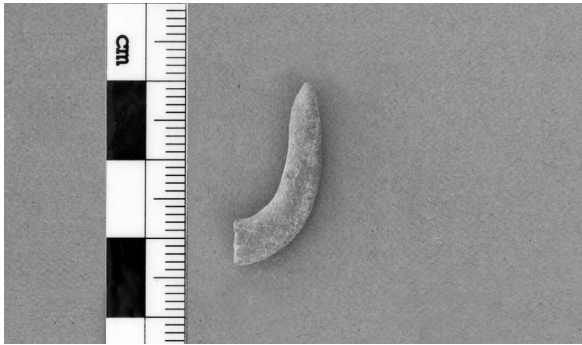


Fig. 22: Horn of a pottery cattle figurine, 224.15-002-021 (photo: Jürgen Dombrowski)

004: 6) with diameters between 1.2 and 2.7cm. One has a hole which goes only partway through the ball (224.15-022-004B). Another clay object is more ovoid, but of similar overall dimensions (224.15-002-054C). These objects may represent workpieces for jewellery or figurines. The production of the latter is evidenced by the discovery of a horn of a cattle figurine from pottery (fig. 22: 224.15-002-021).

A particularly suspicious find group is numerous small clay 'barrels' (fig. 23), between 0.75 and 1.0cm long. They look like workpieces for beads, despite the fact that they are usually unpierced. They seem to have been cut from larger clay rods with a string, as marks on their small ends suggest. Only one piece has a pierced hole width ways (224.15-002-054A). These 'barrels' were found mostly in large groups in the lowest part of the main deposit (224.15-002-054: c. 180 complete pieces + more fragments) and the layers directly underneath (224.15-023-003: c. 50 complete pieces + more fragments; 224.15-000-003⁶⁷: 15 complete + 1 fragmentary piece). A fragmentary pottery 'barrel' of 1.15cm preserved length (fig. 21: 224.15-002-055A) represents the only fired counterpart to these clay 'barrels'. This, again, is unpierced – unless the hole had been at the missing small end – and its function is obscure.

67 According to the post-excavation analysis, the find context was either 224.15-023 or -024.



Fig. 23: Clay 'barrels', 224.15-002-054 (photo: Jürgen Dombrowski)



Fig. 24: Enigmatic pottery objects, 224.15-002-030 and -011 (photo: Jürgen Dombrowski)

Jewellery proper is exceedingly rare⁶⁸ and confined to an isolated faience ring bead from the fill of an 'early' pit (224.15-030-008). The remainder of the find material is stone and pottery objects of unidentified function:

- a fragmentary small drop-shaped stone object (224.15-001-007)
- a fragmentary oblong pottery object, folded and with incised grooves (fig. 24: 224.15-002-030)
- a fragmentary squat pottery object, decorated with rows of comb impressions, from a comb with a minimum of ten teeth; a maximum of three rows are preserved (fig. 24: 224.15-002-011).

68 This situation mirrors the record of trench 224.14 where only one pottery bead was found; cf. Näser and Wetendorf 2014: 83, fig. 22.



ARCHAEOLOGICAL INVESTIGATIONS OF ROOM 225

In order to supplement the findings from courtyard 224, the trenches in room 225, which has been assumed to have been the pottery workshop proper,⁶⁹ were reopened. Room 225, in the north-western corner of courtyard 224 (fig. 1), was first investigated in 1965/66, and a potter's wheel was found there, identified as such by David Edwards thirty years after its discovery.⁷⁰

According to the documentation of the 1960s, room 225, which measured about 5.6 x 3.2m, had been investigated in three trenches.⁷¹ However, upon clearing the room in January 2015, no trench outlines appeared. Instead it showed that the room had been completely emptied in the 1960s and had then been refilled. In retrospect, this explains an entry in the 1965/66 excavation diary: While the excavation of trenches 2251 and 2252 is mentioned on 26 and 27 December 1965 – it took only two days to clear both trenches –, a general (site) inspection is recorded on 31 January 1966, and one of the many observations concerns room 225: “Die Ausgrabung von Raum 225 ergab einen Wohn- oder Küchenraum, der durch sekundäre Einbauten unterteilt ist. Es zeigen sich 3 Wohnniveaus; die durch die sekundären Einbauten abgeteilten Fächer waren teilweise mit Nilschlamm gefüllt. Die Einbaumauer auf dem 2. Wohnniveau ist aus gebrannten Ziegeln aufgebaut. (Eine Läuferreihe: Ziegelformat 40 x 20 x 6/7).“⁷² Obviously the entire room had been cleared in January 1966 without any further mention.

Upon the removal of the fill in January 2015, it showed that the 1965/66 excavations had stopped short of several installations in room 225 which were still *in situ*. Thus, the task was to investigate these installations and what remained of the stratigraphy in order to understand as much as possible of the use life of the room. As already mentioned in the 1965/66 documentation, room 225 had been compartmentalised in antiquity (figs. 25–28). The dominating installations were a basin, which had been built against the south wall, and a small partition wall at its eastern side, which closed off a small space in the south-

eastern corner of the room. In a successive phase, another partition had been installed in the western part of the room with a simple construction of red bricks which ran from the northwestern corner of the basin towards north (figs. 25–28).

With most of the archaeological deposit that was once on top of these installations missing, it was difficult to correlate and date the individual construction episodes and the accompanying phases of use, abandonment and re-occupation. However, as the deposits underneath the described partitions were still in place, seminal data on the early history of room 225 could be gathered. The main source of these data was the slightly offset section CC', which documented the stratigraphy underneath the brick partition and the western basin wall (figs. 25, 29). It shows the natural ground (225.3-019) and a layer which was, somewhat hesitatingly, interpreted as the leached horizon (225.3-018) overlain by a package of silty-sandy layers (225.3-017, -016, -020). All of these layers were cut by what appeared to be a foundation trench of wall 225/N (225.3-021). If this interpretation is correct, a 14C date obtained from a sample from layer 225.3-016 (fig. 29) gives a *terminus post quem* for the construction of this wall:

Poz-73431 (Musa15 225.3-016-001): 2070 ± 30 BP
68.2% probability
155BC (12.2%) 136BC
114BC (56.0%) 45BC
95.4% probability
174BC (92.6%) 19BC
13BC (2.8%) 1BC

In addition, wall 225/224S was constructed after this date, as its building horizon (225.3-015) directly overlies context 225.3-016 from which the sample derives. After the construction of the walls, a layer of coarse sandy material (225.3-014) accumulated. On top of this layer, both the sandstone heightening of the basin (225.3-012) and the brick partitioning (225.3-007) were constructed.

A similarly 'early' sequence was obtained from trench BB' which cut the basin (figs. 25, 30). There the remaining stratigraphy reached a local height of 10.52m which corresponds to layers 225.3-016/017 in section CC'. The eastern section of trench BB' (fig. 31) shows that wall 225/N had been built on the leached horizon (225.3-018) with the building horizon (225.3-026) being clearly visible. A package of silty-sandy sediments (225.3-025, -027) accumulated on top. Subsequently, the basin was dug into these sediments, down to the natural ground (225.3-019).

69 Wenig in Edwards 1999: 4, 6; cf. Edwards 1999: 38.

70 See Edwards 1999: 42, fig. 5, pls. 6.32–34 and Onasch 2004: fig. 2, and for the find context of the object, below p. 63.

71 Hintze 1967–1968: 297, plan 4, 1968: 681, plan 4: 2251, 2252, 2243, which was enlarged to include entrance 224-225 into room 225. Cf. also Onasch 2004: 63–65.

72 Objektbuch Komplex 200, 1965: 17–20, 50, 66–67, 72 = Doku.-Vz. 89, Archive of the Department of Northeast African Archaeology, Humboldt University Berlin. Cf. also Raumbuch 100–400, pages marked 224, 225/224, no Doku.-Vz. number.



Fig. 25: Plane 2 of trench 225.3 (drawing: Claudia Näser, Stephanie Bruck; graphic implementation: Christiane Dorstewitz)



Fig. 26: View of plane 2 in trench 225.3 from west (photo: Claudia Näser)



Fig. 27: The basin and the compartment in the southeastern part of room 225 (photo: Claudia Näser)



Fig. 28: The central and the western part of room 225 (photo: Claudia Näser)

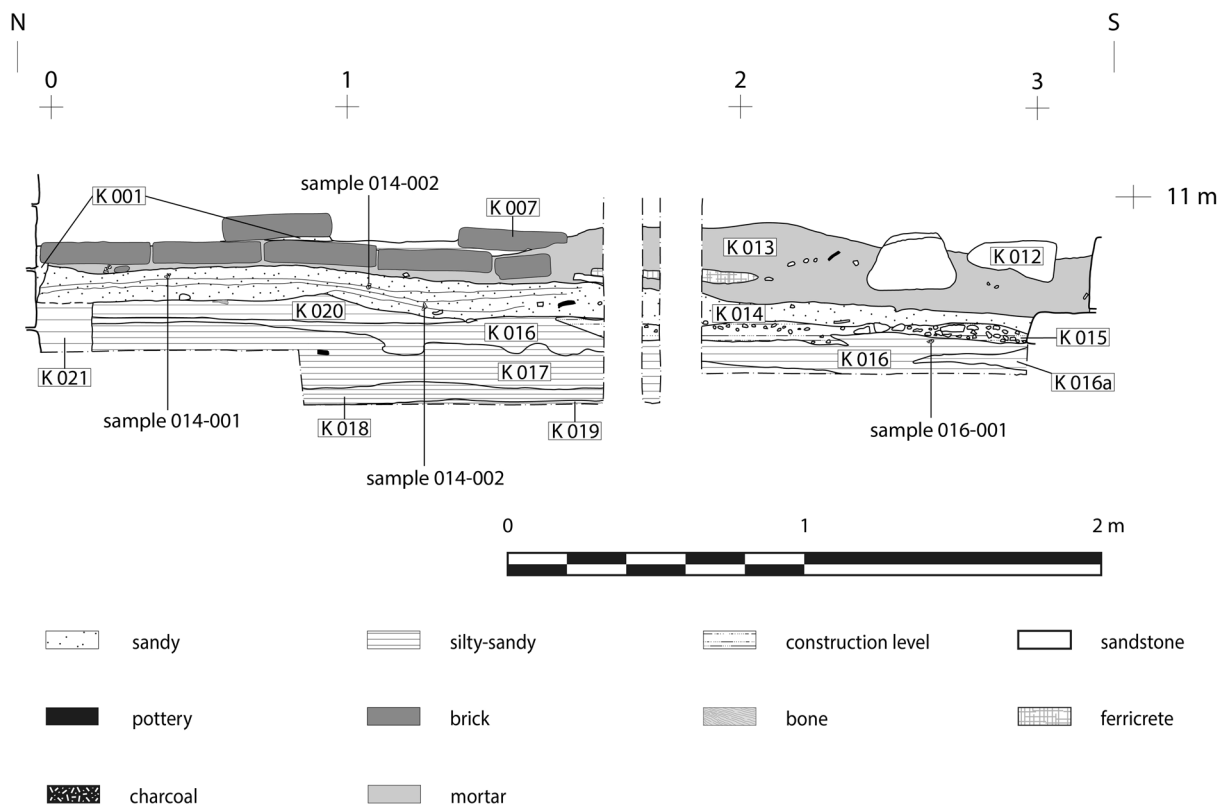


Fig. 29: Section CC' (drawing: Claudia Näser; graphic implementation: Christiane Dorstewitz)



Fig. 30: The southern part of trench BB' (photo: Claudia Näser)

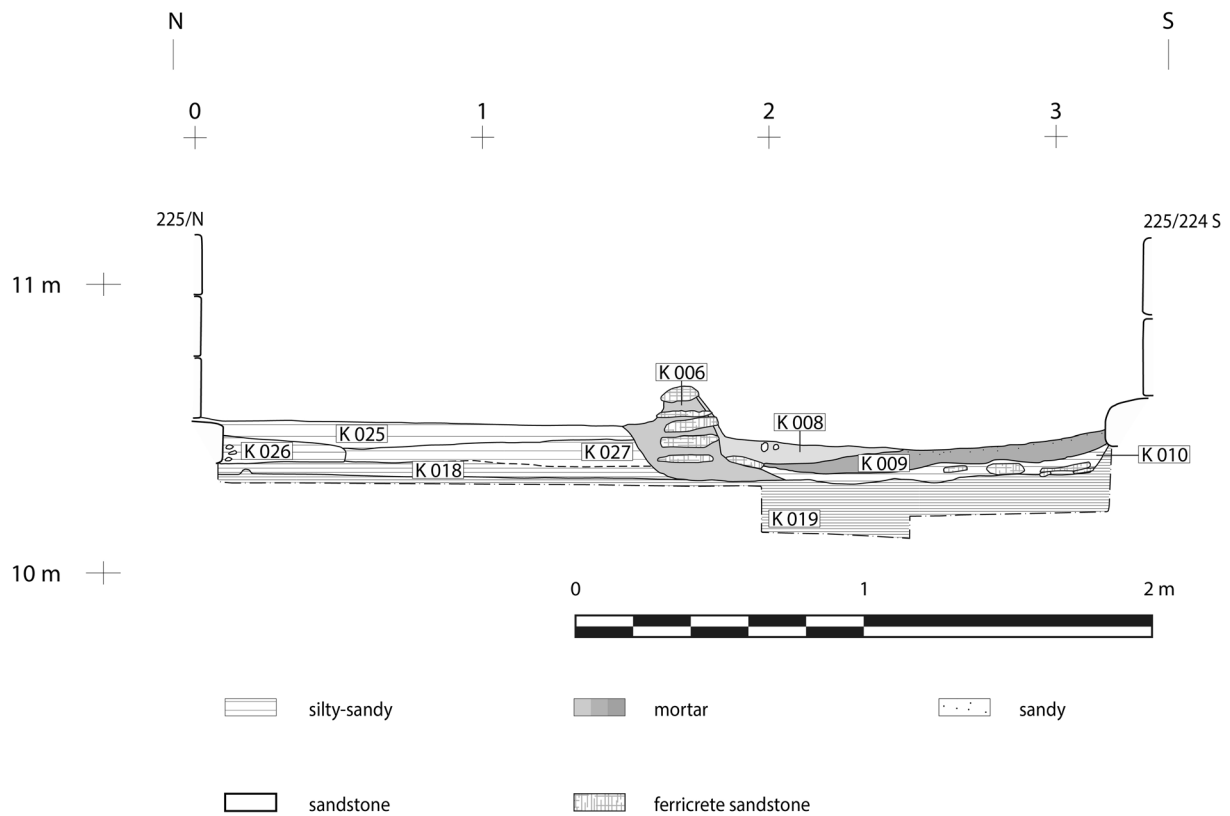


Fig. 31: The eastern section of trench BB' (drawing: Claudia Näser; graphic implementation: Christiane Dorstewitz)



Fig. 32: The eastern section of trench BB' inside the basin (photo: Claudia Näser)

The edges of the basin were lined with walls of ferricrete slabs set in heavy layers of grey mortar. This mortar had been daubed widely on the surrounding floors, the base of the wall being up to 55cm wide. The inner floor of the basin was constructed of similar ferricrete slabs and smaller stones (figs. 25–28, 30–33) set in a bed of mortar which was somewhat different in appearance from that used for the walls (fig. 31–32). The basin had been dug to

a depth lower than the foundation layer of wall 225/224S with the consequence that the basin floor was drawn upwards in the south to abut the foundation of the wall. This shows clearly that the basin postdates the construction of wall 225/224S.

Another set of features in room 225 were several 'fire pots', i.e. truncated parts of large ceramic vessels which had been installed upside down in the ground, serving as hearths or the outlines of fireplaces. Such installations have not yet been studied in detail, but

seem to have been a common cooking device in the Meroitic period.⁷³ One of these 'fire pots' appeared underneath the basin (figs. 30, 33–35: 225.3-030). Its upper part had been sliced off, probably to prepare it for its secondary use. It was sunk into the

⁷³ Cf. e.g. Wolf et al. 2009: 248–249, fig. 38, 2011: 232–234, figs. 19–20, but note that the specimens described there were not inverted!



natural ground (225.3-019) and later sealed by the basin. The only other features exposed to date which are stratigraphically related to this occupation horizon are two small pits (225.3-028, -029) about 40cm further south (fig. 30). They had diameters of 10cm to 13cm and depths of 10cm and 5cm respectively, and were both filled with an inhomogeneous silty-sandy material.

Three other 'fire pots' had already been found by Hintze and his colleagues (figs. 25, 35: 225.3-003, -004, -005).⁷⁴ They were left *in situ*, but the surrounding stratigraphy had been cleared away (fig. 28). Stratigraphically, pot 225.3-003 was sitting in layer 225.3-016 (figs. 36–37), for which a date of 2070 ± 30 BP has been obtained (see above). A charcoal sample from its fill was also dated:

Poz-73430 (Musa15 225.3-003-005): 1955 ± 30 BP
 68.2% probability
 8AD (68.2%) 78AD
 95.4% probability
 38BC (89.1%) 90AD
 100AD (6.3%) 123AD

Pot 225.3-003 is preserved to a local height of 10.69m which corresponds to the upper boundary of layer 225.3-014 as it is preserved in section CC' (fig. 29). If the pot had been sunk into a pit in the ground more or less completely, analogous to pot 225.3-030, it would have cut layer 225.3-014 and the building horizon 225.3-015,⁷⁵ which were removed during Hintze's excavations, and should therefore postdate them.

Of the second 'fire pot' in the rear part of the room (figs. 25, 28, 35, 38: 225.3-004), only the bottom part was preserved in isolated sherds which were embedded in context 225.3-017, about 3cm deeper than pot 225.3-003. Nonetheless, the two pots could have been contemporary. It seems likely that they were only installed after the outer enclosure wall 225/N had been built, but no direct stratigraphic proof has been preserved due to the removal of the

74 They are indicated in Hintze 1967–1968: plan 4, 1968: plan 4 as circular features in front of wall 225/601.

75 This horizon is quite pronounced 30cm further east in section CC', drawing about 1.6m into the room (fig. 29). So we can assume that it was also present in the area of the pot.

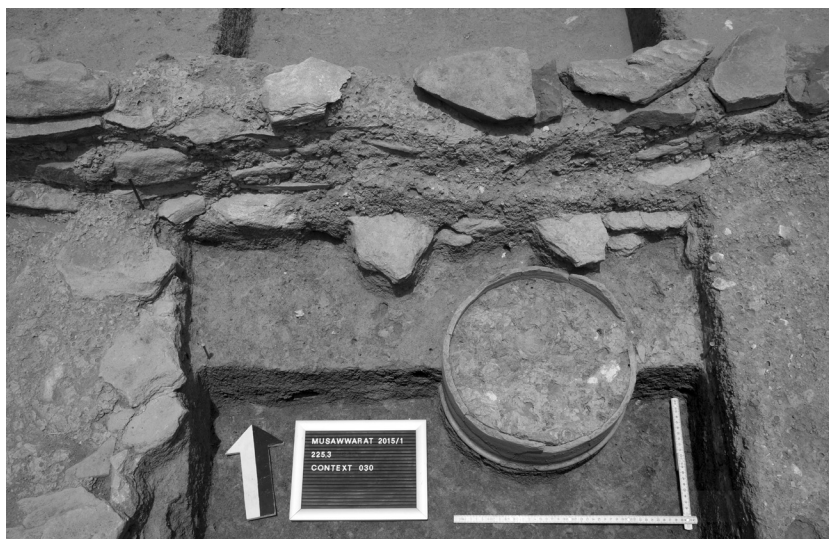


Fig. 33: 'Fire pot' 225.3-030 underneath the basin (photo: Claudia Näser)



Fig. 34: Section through 'fire pot' 225.3-030 (photo: Claudia Näser)

upper parts of the stratigraphy in the 1960s. The same is true for feature 225.3-005 (figs. 25, 28). It consisted of an irregular patch of sediment which showed the impact of burning and the remains of ashes; some sherds (fig. 35) were found on top and around this spot. Obviously, this feature had been compromised by the earlier excavation which had removed the surrounding sediment, leaving it in an insular position. Its lowest part is again embedded in a silty-sandy layer, corresponding in height to layers 225.3-017, -016 and -020, and thus to the positions of pots 225.3-003 and -004.

While 'fire pot' 225.3-030 predates the basin, the other three pots cannot easily be related to the horizon represented by the basin due to the loss of surrounding stratigraphy. In terms of absolute height, they are situated above the layers which are preserved in section BB' (fig. 31) – and should therefore postdate these layers and the construction of the basin.

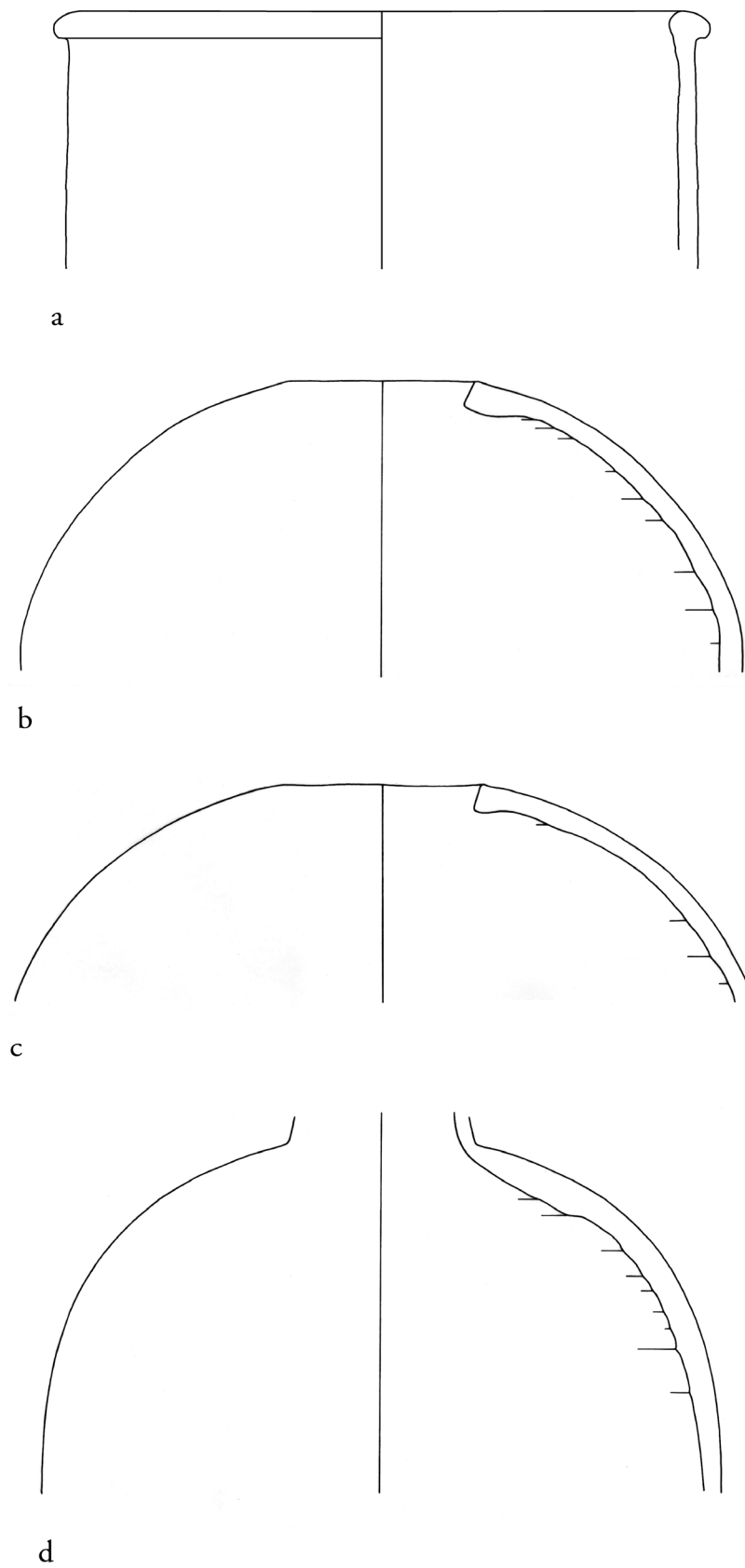
 10 cm

Fig. 35: 'Fire pots' 225.3-030, -003, -004, -005 (drawing: Jaroslav Halik, Claudia Näser; graphic implementation: Manja Wetendorf)

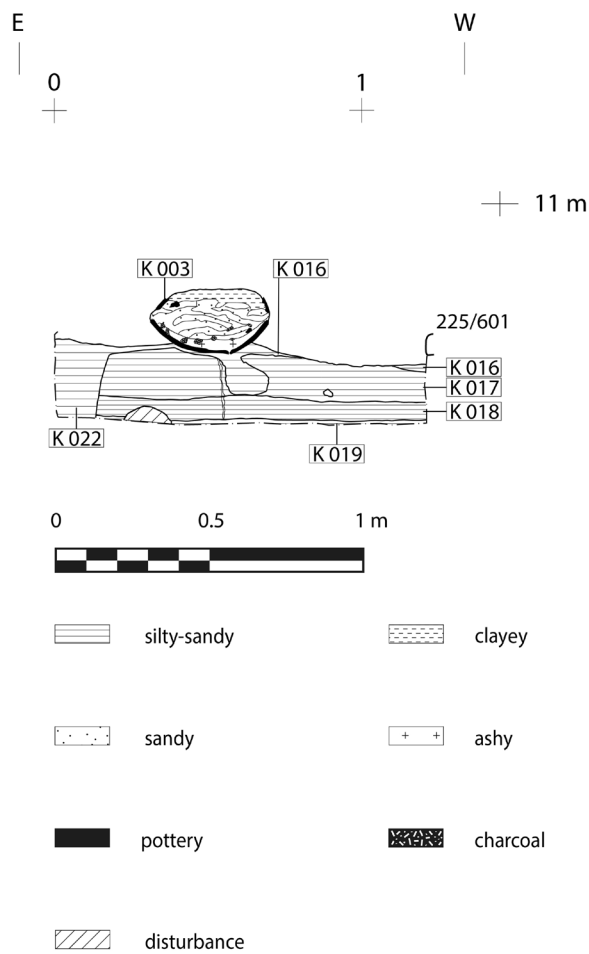


Fig. 36: The southern section of trench AA' (drawing: Stephanie Bruck, Claudia Näser; graphic implementation: Christiane Dorstewitz)

As outlined above, the basin had been built into a shallow pit dug in the central part of room 225 (figs. 25–28, 30). It is roughly rectangular in shape with rounded edges, its interior measuring about 2.1 x 1.3m. The basin walls were constructed from ferricrete sandstone slabs set in heavy mortar, rising only about 20cm above the basin floor (figs. 30–33). While the northern wall is about 20 to 25cm wide, the eastern wall measures up to 35cm wide (fig. 25). From the northeastern corner of the basin, a small partition wall had been constructed towards the east, closing off a small space of roughly 0.9 x 1.5m in the southeastern corner of room 225. The lining at the western side of the basin is designed more like a platform, being up to 65cm wide. This platform as well as the eastern basin wall and the small partition wall to the east were (later?) heightened by large sandstone blocks (225.3-012), which were set in a heavy bed of mortar (225.3-013) in a casual way, many of them upside down. While these stones rise up to 50cm above the basin floor, the northern



Fig. 37: 'Fire pot' 225.3-003 after the removal of its content (photo: Claudia Näser)

wall of the basin is only 20cm high. The basin floor (225.3-010) is partly covered with a dark red sandy material (225.3-009; figs. 25, 30–32). It has only been detected in the southeastern part of the basin and is in turn overlain by a second layer of light grey mortar (225.3-008) which is restricted to the northeastern corner of the basin where it was also smeared up the walls (figs. 25, 30–32). The meaning of this sequence, particularly the red silty-sandy layer, still escapes a conclusive interpretation.

The most curious space, however, is the compartment east of the basin (figs. 25, 27, 39). In its centre the potter's wheel was found sunk into the floor, "in den Boden eingelassen".⁷⁶ The reinvestigation of the spot revealed two sandstones apparently still *in situ* and a discoloured area in the floor (figs. 25, 27, 39). The latter proved to be a pit with an egg-shaped outline (figs. 25, 40: 225.3-024), 46cm wide, 7cm deep, and filled with a very inhomogeneous light grey sediment, including small sandstone fragments and chunks of a hard whitish material, but also two large animal bones stuck in vertically. This pit in turn was sunk into a larger depression (figs. 25, 40: 225.3-034), which extended over the whole western part of the compartment and was filled with the silty-sandy grey to brownish material which consequently also formed the floor of the partition and eventually merged into the mortar of the partition wall.⁷⁷ This depression had been dug into the silty-sandy sediments (225.3-025/027) above the natural ground (225.3-019) – probably at the same time as

⁷⁶ Objektbuch Komplex 200, 1965: 20 = Doku.-Vz. 89, Archive of the Department of Northeast African Archaeology, Humboldt University Berlin.

⁷⁷ Context 225.3-036 in the reproduced section (fig. 40) is a layer of a distinctly red silty-sandy material which in part seems to underlie the wall of the compartment (225.3-006/012), but has been truncated in the excavations of the 1960s. For context 225.3-035 see the next paragraph.



Fig. 38: The *in-situ* remains of 'fire pot' 225.3-004 (photo: Claudia Näser)



Fig. 39: The compartment in the southeastern corner of room 225 (photo: Claudia Näser)

the pit for the basin was excavated. The floor of the compartment rises slightly towards the surrounding walls, from a maximum depth of 10.41m in the centre, which about equals the floor of the adjacent basin (fig. 25).

In the southeastern corner of the compartment a stump of the original stratigraphy had been left standing (figs. 25, 27, 39, 41). While it was very weathered, its analysis revealed part of the strata which have been lost everywhere else in the room. They consisted of a heavy package of silty-sandy layers (225.3-031) which rest on a floor (225.3-011) drawing over the foundation layer of walls 225/224E+S, a building horizon (225.3-015) and a silty-sandy layer (225.3-032) (fig. 41). As the occupation horizon of the compartment (225.3-034, -025) is distinctly deeper than the foundation layer of wall 225/224E+S, one must assume that the building hori-

zon (225.3-015) and the floor level (225.3-011) preserved in the stump were dug away prior to the construction of the compartment – possibly when the basin was also excavated. An unsolved puzzle is why the stump, or its lower part, had been left standing at that point. Interestingly, the threshold to the partition (figs. 25, 39–40, 225.3-035), which in its composition equals a building horizon with many sandstone chips and ground stone material, is at exactly the same height as the building horizon 225.3-015 preserved in the stump and may be a leftover or a deliberate (re)deposition of this material. Obviously, the reconstruction of these stratigraphic relationships is seriously hampered by the truncated nature of the surviving record.

One feature still needs to be mentioned, namely the brick partition wall which runs from the northwestern corner of the basin towards wall 225/N (figs. 25–26, 28–29, 225.3-007). It consisted of large red bricks (see above p. 56), set in a single row of stretchers, two courses high. Three displaced bricks were found

on both sides of the wall. As the upper course *in situ* has space for another 2 ½ bricks only, one must assume that either one of the collapsed bricks had been set crossways or a third layer had originally existed. The brick partition seems to rest in the same bed of mortar (225.3-013) like the sandstone blocks on top of the western basin wall (225.3-012). As both contexts overlie layer 225.3-014 (fig. 29), they probably represent a later addition to the basin.

In sum, the following occupational sequence can be reconstructed for room 225:

- walls 225/N+601 were built, according to Hintze in the 6th building period, at that time forming the northeastern outer corner of the Great Enclosure⁷⁸

⁷⁸ Hintze and Hintze 1970: sketch 4; cf. Wenig in Edwards 1999: 6.

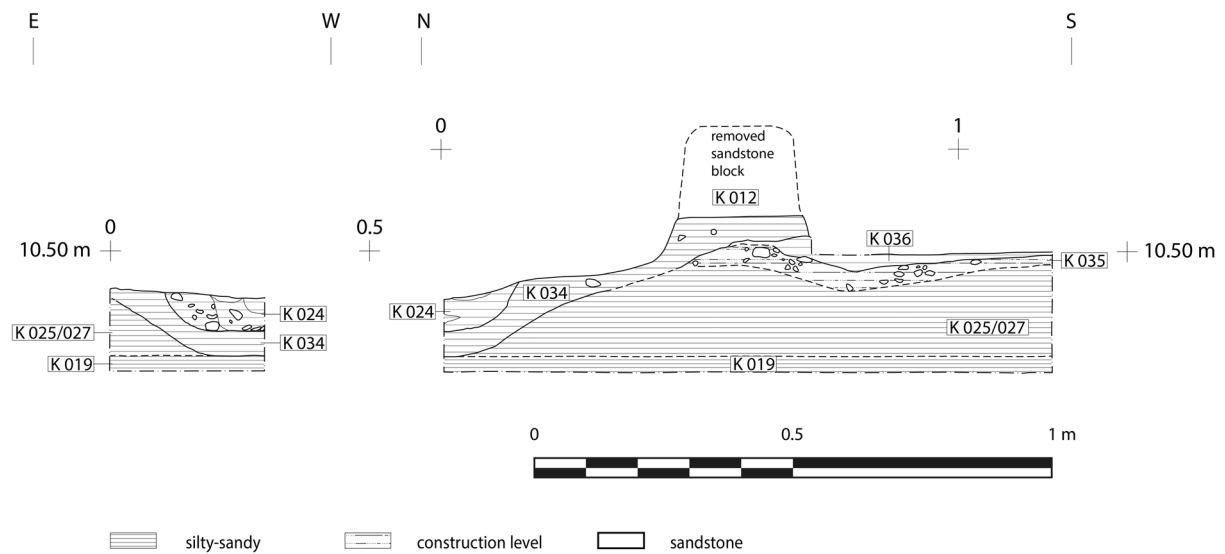


Fig. 40: The southern and western sections of trench FF' (drawing: Claudia Näser; graphic implementation: Christiane Dorstewitz)

- 'fire pot' 225.3-030 was installed
- silty-sandy layers accumulated south of wall 225/N
- walls 225/224S+E were added after 2070 ± 30 BP (Poz-73431)
- the pit for the basin was dug and the basin was constructed along with the compartment east of it
- three more 'fire pots' (225.3-003, -004, -005) were installed; no direct stratigraphic relationship with the basin could be established, but they may post-date its construction; from the content of 225.3-003 a date of 1955 ± 30 BP (Poz-73430) was obtained
- at some unknown point in time the sandstone blocks on the walls east and west of the basin were added and the brick partition in the western part of the room was built
- a later occupation phase is evidenced by the bottom of a vessel which was recorded *in situ* in trench 225.2 at a height of about 11.05m in the 1960s excavations.⁷⁹

While the excavators of the 1960s originally assumed that room 225 had served as a living and kitchen room⁸⁰, they later described it as a "Wirtschaftsraum" or workshop.⁸¹ Only after the identification of the potter's wheel was it suggested to have been the

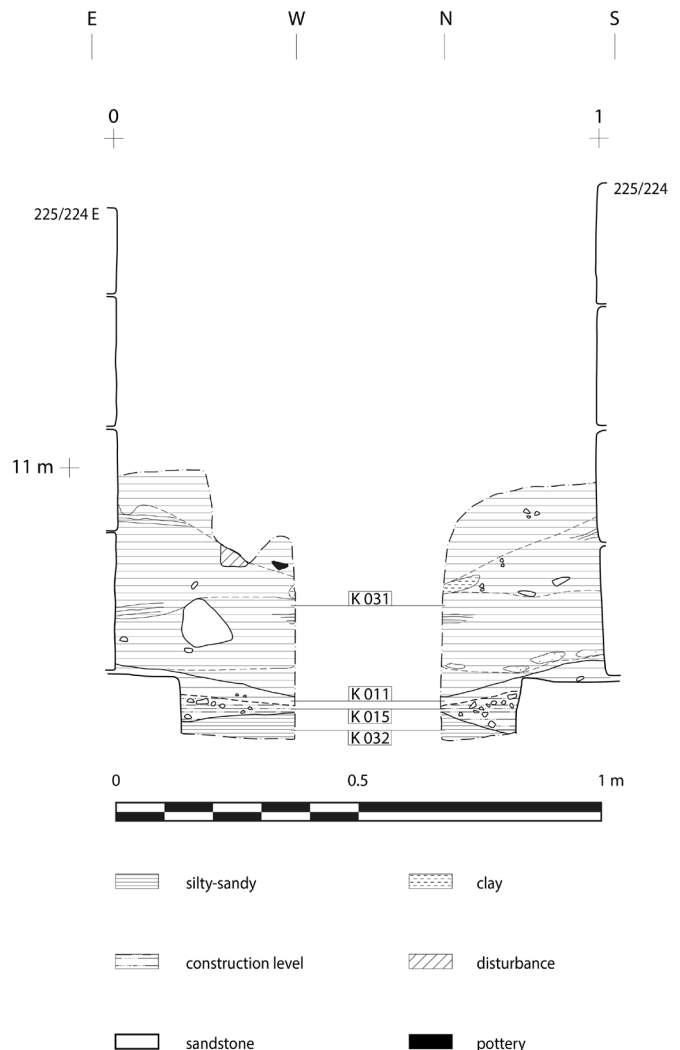


Fig. 41: The northern and western sections of the stump in the southeastern corner of room 255 (drawing: Claudia Näser; graphic implementation: Christiane Dorstewitz)

⁷⁹ Objektbuch Komplex 200, 1965: 20 = Doku.-Vz. 89, Archive of the Department of Northeast African Archaeology, Humboldt University Berlin; dito Onasch 2004: 65.

⁸⁰ Objektbuch Komplex 200, 1965, 66–67 = Doku.-Vz. 89, Archive of the Department of Northeast African Archaeology, Humboldt University Berlin: "Die Ausgrabung von Raum 225 ergab einen Wohn- oder Küchenraum [...]."

⁸¹ Hintze 1967–1968: 297, 1968: 681.

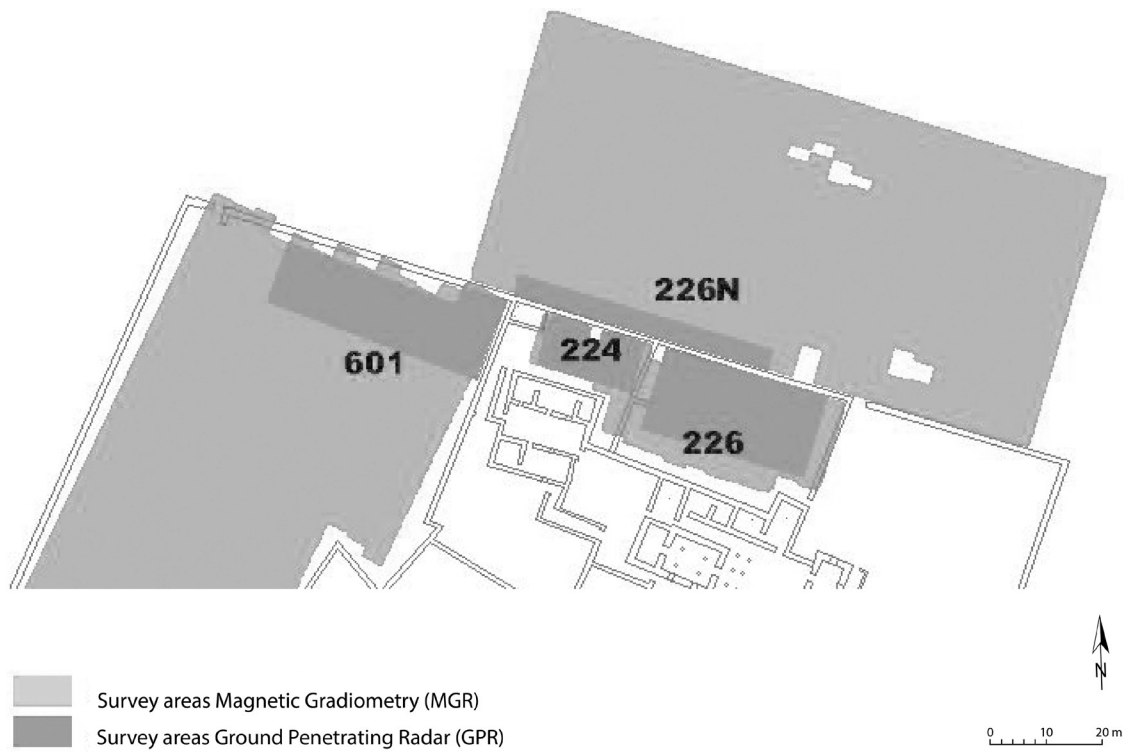


Fig. 42: Plan of the areas explored in the geophysical survey (mapping: Eastern Atlas GmbH & Co. KG, Berlin)

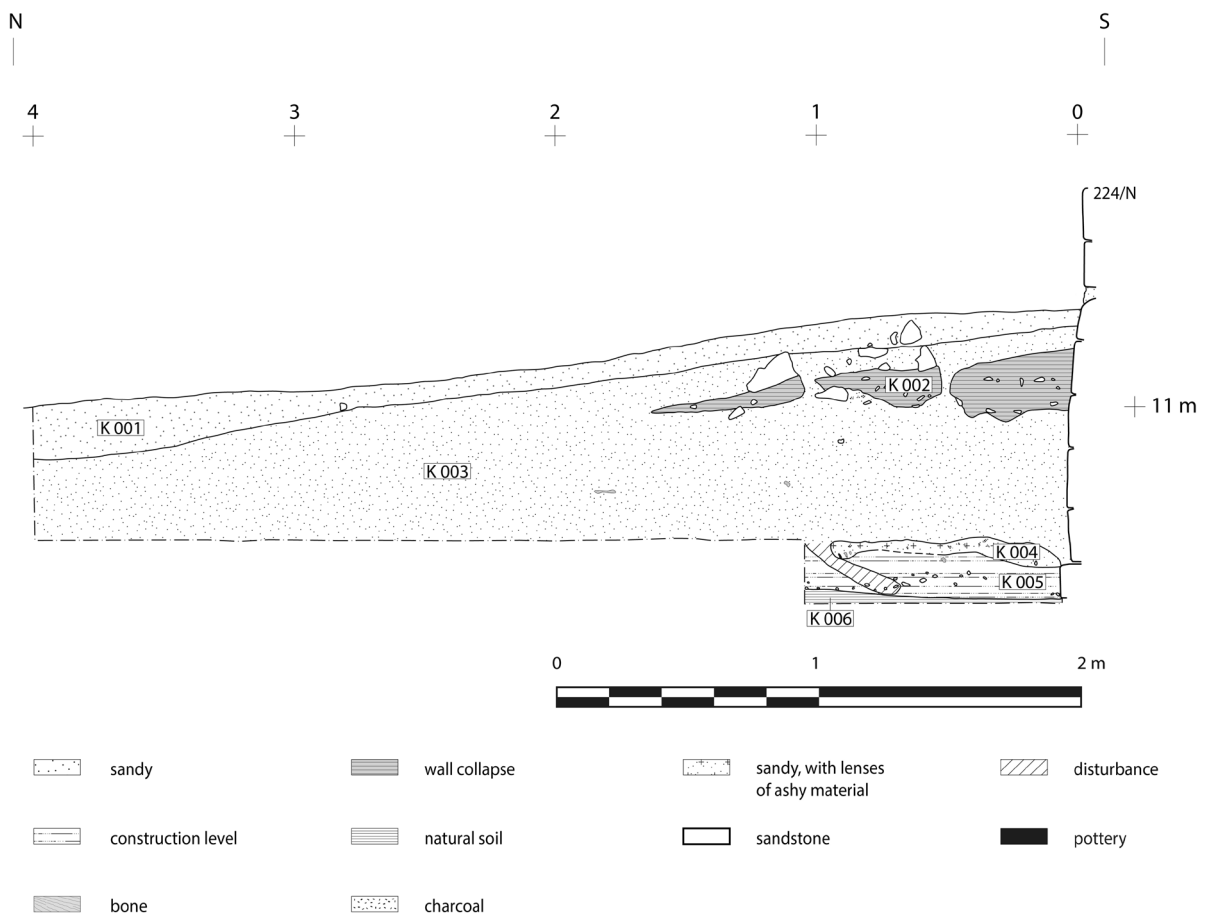


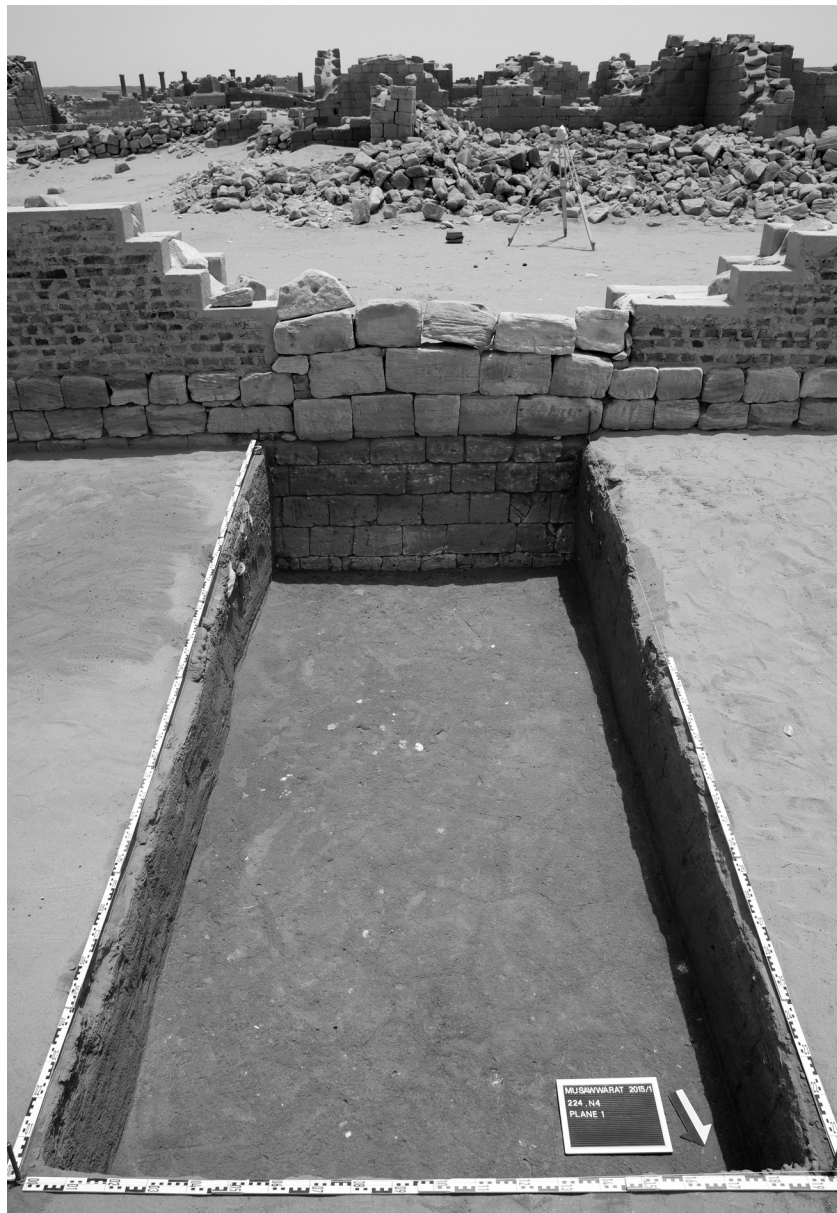
Fig. 43: The eastern section of trench 224.N4 (drawing: Claudia Näser; graphic implementation: Christiane Dorstewitz)



actual potter's workshop.⁸² An evaluation of this theory in the light of the recent findings will be given in the final section of this paper.

GEOPHYSICAL INVESTIGATIONS

In order to trace the loci of pottery production and widen the exploration of courtyard 224 and its surroundings, geophysical investigations were conducted in the spring season 2015.⁸³ Magnetic Gradiometry (MGR) was used on courtyards 224, 226 and 601 as well as on a 104 x 50m stretch north of the enclosure wall (fig. 42). Ground Penetrating Radar (GPR) was applied to courtyards 224, 226, an area of 40 x 15m in the northeastern part of courtyard 601 and a 46 x 4m stretch north of the enclosure wall (fig. 42). Anomalies were scarce, and none of the features detected could be related to the assumed pottery production. Thus, the main result of this survey was that it again reduced the likelihood that hitherto undetected kilns exist in or near courtyard 224.⁸⁴



TRENCH 224.N4

Fig. 44: Plane 1 of trench 224.N4 (photo: Claudia Näser)

The result of the geophysical investigation was further confirmed by the findings of trench 224.N4. This 2 x 4m trench was laid out north of the enclosure wall, corresponding to trench 224.15 at the interior (fig. 1). The stratigraphy exposed in the trench consisted of almost one metre of sand accumulations (fig. 43: 224.N4-001, -003), enclosing only a layer

of wall collapse (224.N4-002).⁸⁵ The only deposit connected to human occupation was a sandy layer, 224.N4-004, which appeared 10cm above the foundation layer of wall 224/N (figs. 43–44). Parts of it were coloured grey from concentrations of ash, and it also contained charcoal, pottery and animal bones.⁸⁶ A sondage dug down to the natural ground in front of wall 224/N revealed a rather ill-defined building horizon (224.N4-005) which was disturbed by one or several pits or depressions. Thus, traces of human activities immediately outside of 'pottery courtyard'

⁸² Wenig in Edwards 1999: 4, 6; cf. Edwards 1999: 38.

⁸³ The collection, processing and interpretation of data were undertaken by Burkart Ullrich, Rudolf Kniess and Nikolaas Noorda of Eastern Atlas GmbH & Co. KG, Berlin.

⁸⁴ For the evidence of such kilns in Muweis, Meroe and Hamadab see Baud 2008: 53–54, fig. 1, 2010: 215–216, figs. 278–279; Török 1997: 173–174, fig. 1 and Wolf et al. 2011: 234–237, figs. 21–22.

⁸⁵ These layers correspond to context [611] in trench 224.N3 4m to the east (fig. 1) which was investigated in 1997; see Edwards and Onasch in Edwards 1999: 11–12, fig. 7.

⁸⁶ The layer corresponds to context [623] in trench 224.N3; see Edwards and Onasch in Edwards 1999: 11, fig. 7.



224 consisted mainly of a limited amount of domestic waste and dispersed ashes, probably from cooking, in a position corresponding in height to the upper floor (figs. 2–3: 224.15-006) in trench 224.15 at the interior of the wall.

However, the negative evidence from the geophysical investigations and the excavation of trench 224.N4 is again, to a certain degree, thwarted by one isolated find: a lump of slag, with a maximum diameter of 8cm, which in part still preserves the negative shape of the crucible from which it came (224.N4-003-003). The piece was found in the lower part of the sand accumulation 224.N4-003 at a local height of 10.70m. While it was clearly in a secondary position, it again hints to the existence of firing, or even smelting, installations nearby, from where it would have been removed to its present find spot.

ETHNOARCHAEOLOGICAL INVESTIGATIONS

A comparison of the sections of trenches 224.15 and 224.N4 (figs. 3, 43) very clearly demonstrates that the deposit inside the enclosure wall 224/N was accumulated as a heap, rising up to 80cm above the surrounding occupation horizon. The portion of the enclosure wall which had been exposed in trench 224.15 showed particularly heavy damage with parts of three block layers missing and the surfaces of the remaining blocks largely lost (colour fig. 4). The blocks in the first layer above the foundation show the typical crescent-like dark red to black discolourations which suggest the strong localised impact of heat. This record corresponds to the findings on other walls in the area of the deposit which feature similar discolourations and destructed block surfaces.⁸⁷ While Wolf⁸⁸ and Wenig⁸⁹ assumed that these traces derive from kilns which once stood in these locations, this has been doubted by Edwards⁹⁰ and Onasch⁹¹.

In order to enquire whether the accumulation of the deposit could have been directly related to the firing of pottery i.e. whether the heap represents the gradual build-up of an actual open (bon)firing place, an ethnoarchaeological investigation was conducted at a potter's workshop in Shendi. Situated in the mainly residential area of Gala Sheinan (north 16° 41.013, east 033° 25.096), the workshop is run by a

single female potter who mainly caters for the local market. She produces the vessels by hand in her compound, but fires them in the open in a public square in front of her house (fig. 45). The location is characterised by an extensive amorphous build-up of ash, measuring more over 10m in diameter and 1m in height, deriving from an unknown number of firing events. Several metal sheets which are used to cover the firing stack as well as broken pots and wasters can be found lying about.

We excavated a trench of roughly 2.6 x 1.2m in the centre of this accumulation. As the recorded section (fig. 46) shows, its stratigraphy is quite different from that of the deposit in courtyard 224 (figs. 2–3). The firing place in Shendi has a clear sequence of mainly sandy-ashy layers which may represent individual firing episodes, interspersed with other materials and a conspicuous amount of rubbish. The deposit in courtyard 224 is lacking this internal differentiation. It also contains a much higher amount of potsherds and stone rubble; both components are virtually absent from the Shendi kom. Thus, while the ethnoarchaeological investigation gave valuable insights into the appearance of an open (bon)firing place associated with a current pottery workshop, it does not directly help us to understand the formation of the Musawwarat deposit. What the comparison underlines, however, is the exceptional nature of this deposit and the continued need for its explanation.

INTERPRETATION AND PERSPECTIVES

While most previous contributors⁹² have seen the deposit in courtyard 224 in connection with kilns or open bonfires on the spot or in the immediate vicinity, Edwards⁹³ suggested that it represents a secondary dumping, as the pottery from it showed a high degree of fragmentation and sherds of individual vessels were repeatedly found widely dispersed throughout the accumulation. However, the consistency of the dumped material speaks against this theory – it is extremely loose and difficult to move, and it is not conceivable why it should have been redeposited inside the enclosure wall or from where it could have been transported to this place.⁹⁴ The wall portions which were heavily affected by heat suggest that the pottery was indeed fired on the spot. They are present throughout the area of the deposit and also occur in the most recent trench

87 Näser and Wetendorf 2014: 75–76, Edwards and Onasch in Edwards 1999: 11, fig. 9.

88 1997: 27.

89 In Edwards 1999: 6.

90 1999: 41.

91 2004: 67–69.

92 Wolf 1997: 27; Wenig in Edwards 1999: 6; Onasch 2004: 67–69.

93 1999: 37.

94 Cf. Näser and Wetendorf 2014: 91–92.



Fig. 45: The pottery firing place in Shendi with the compound of the potter in the back (photo: Claudia Näser)

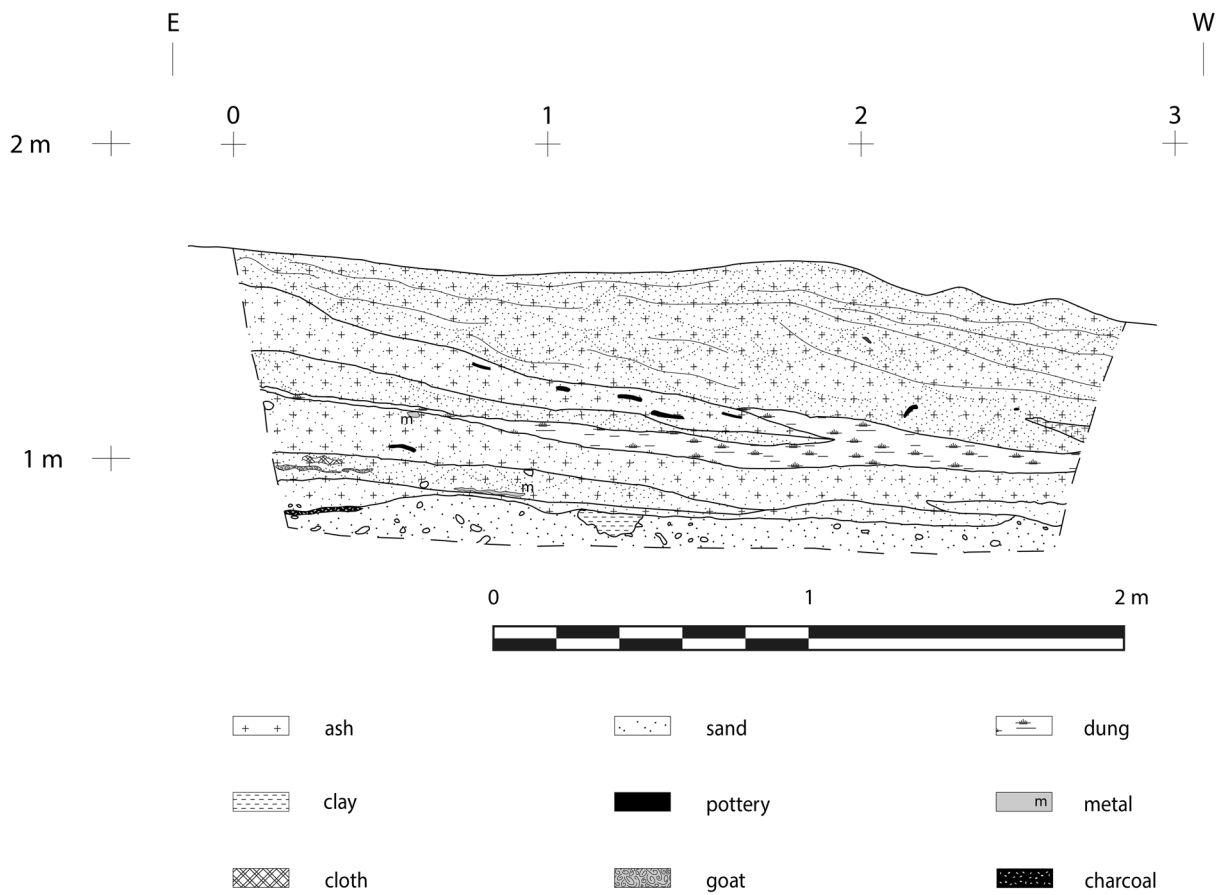


Fig. 46: The southern section of the trench through the firing place (drawing and graphic implementation: Christiane Dorstewitz)



224.15. Whether the mudbrick structure exposed in trenches 224.14+15 represents the remains of a firing installation could, however, not be ascertained. Burn marks on the two associated floors may be indicators in this respect – but again the record is too unspecific for definite conclusions. The deposit includes lenses of other materials, i.e. raw clay and production debris, which doubtlessly were dumped in this spot. Thus, it seems most likely that the entire assemblage represents shifting activity zones of an extended production area: first the spot was used as a firing place, and when the firing was later moved, the debris from the new place was deposited in the abandoned area, together with other production waste.⁹⁵

In order to further supplement the diverse strands of the investigations – excavations, geophysical prospection and ethnoarchaeological comparisons – a final line of enquiry was opened. The matrix of the deposit was analysed in order to reveal details of the firing process, namely which firing materials had been used and to what temperature they had been burnt. The data obtained in this respect should then allow us to better characterise the associated firing installations. Next to the ash from the deposit itself, comparative samples of potential firing materials, both plant and dung, prepared from modern specimens, were studied. The result came as a complete surprise: what had been described as ‘ash’ to date is not in fact decomposed organic matter, but mullite – a rare silicate mineral which forms under certain conditions during the firing of porcelain and pottery from kaolinite clay. Mullite has never been detected in archaeological contexts in the Nile Valley before. While again not answering the pending questions about firing installations, this result opens a completely new chapter in the study of pottery production and its technological parameters in the Middle Nile Valley.⁹⁶

A similar effect – namely that the advancement of the investigation at least for a while posed more questions than it answered – was observed in connection with the re-examination of room 225. The potter’s wheel which was found in this room is in fact only the lower part of such a device, namely the wheel bearing, consisting of the socket stone, which had been fixed to the ground, and the upper pivot stone, to which a wheel head was fixed. No

traces of a wheel head have been reported from Musawwarat.⁹⁷ According to the documentation of the 1960s, the wheel, or rather its socket stone, had been sunk in the floor of the eastern compartment of room 225.⁹⁸ While indeed a pit was recorded in this space, it was found to contain an apparently undisturbed fill, without any signs of the wheel having been removed from it. More likely, the socket stone had been fixed above ground with clay or mortar.⁹⁹ Another puzzle is posed by the size of the room. The wheel head would have had a diameter of 50cm or more¹⁰⁰, leaving almost no space to set it spinning or to accommodate any other movements or activities in the confined space of the compartment which only measured 1.5 x 0.85m. The potter working the wheel would have had to sit on one of the partition walls – which would have provided a good working height, but may have been quite uncomfortable otherwise. On the other hand, the wheel could have been a banding wheel used in decorating the pottery, an activity which would probably have required less space.¹⁰¹ The basin in the centre of room 225 represents a very appropriate installation to prepare or temporarily store clay and keep it clean, wet and close at hand for the potter. In fact, the records of the 1960s state that the partitions of the room were partly filled with Nile silt, “die durch die sekundären Einbauten abgeteilten Fächer waren teilweise mit Nilschlamm gefüllt”¹⁰² – an observation which may refer to a residue, if not necessarily Nile silt, in the basin. All in all, the findings corroborate that room 225 served as a potter’s workplace.

The same is true for the current corpus of small finds from the main deposit. They comprise numerous objects and material related to pottery production, including a possible turning device, tools for decorating and polishing, and the enigmatic new category of the unfired clay ‘barrels’. In sum, this assemblage again confirms that the shaping and decoration of pottery vessels and possibly other pottery objects must have taken place close by. The dating of the different occupation phases of courtyard 224 has been further refined, with the main ‘pottery horizon’ being placed into the late 1st century BC or the 1st century AD. This makes Musawwarat the oldest

95 Cf. Näser and Wetendorf 2014: 78, 91. The material from trench 224.15 again confirmed the near absence of wasters; contra the findings of Edwards 1999: 37.

96 The analyses were undertaken by Malgorzata Daszkiewicz and Gerwulf Schneider. A detailed interpretation of the findings is currently prepared by them and the authors of this contribution.

97 For the wheel from Musawwarat and basic bibliographical references see Edwards 1999: 42, fig. 5, pls. 6.32–34. For the question of wheel heads see now also Smith 2014.

98 See above, p. 63.

99 Cf. Powell 1995: fig. 10.7.

100 See Powell 1995.

101 Dito Edwards 1999: 42; cf. Powell 1995: 333.

102 Objektbuch Komplex 200, 1965: 66 = Doku.-Vz. 89, Archive of the Department of Northeast African Archaeology, Humboldt University Berlin.



securely dated site for the production of Meroitic fineware ceramics.

The ongoing archaeometric analyses now allow us to clearly characterise the local production of both fine and coarse wares. Likewise, they provoke the revision of some more general assumptions about the organisation and dynamics of pottery production. One case in point is the distribution of hand- and wheelmade wares: contrary to the widespread postulate that handmade wares represent local household productions, while finewares testify to the existence of nucleated workshops,¹⁰³ handmade wares in Musawwarat were made from non-local clays and represent imports, while fineware pottery was produced primarily for 'home requirements'. It is hoped that continued archaeological investigations as well as the ongoing analysis of raw materials, production debris and finished pottery will provide the basis to further elaborate upon these results in the coming project phases.¹⁰⁴

POSTSCRIPT

After the submission of the manuscript, a 14C date from the fill of 'fire pot' 225.3-030 (cf. above, p. 60, figs. 30, 33–34) was obtained:

Poz-76014 (Musa15 225.3-030-002): **2165 ± 30 BP**
 68.2% probability
 352BC (36.9%) 298BC
 228BC (3.0%) 222BC
 211BC (28.3%) 171BC
 95.4% probability
359BC (44.7%) 274BC
261BC (46.0%) 149BC
 140BC (4.6%) 112BC

This date confirms the occupational sequence of room 225 and the suspected age of the 'fire pot' in question (cf. above, p. 64–65). It falls into the same range as several dates from 'early' features in trenches 224.14 and 224.15, namely the lower floor 224.15-009 and pits 224.14-015, 224.15-026 and -010 (cf. above, p. 39–40, and Näser and Wetendorf 2014: 78). This clustering in the 4th to 2nd centuries BC is mirrored in dates from surrounding excavations, e.g. in Temple 200 (Näser 2013: 13–14). The implications of this finding for the building history of the northern part of the Great Enclosure will be discussed in next year's issue of 'Der antike Sudan'.

103 Cf. e.g. Costin 1991.

104 Cf. also Daszkiewicz and Wetendorf, this volume.

BIBLIOGRAPHY

- Bąkowska, G. (2010): Meroitic pottery from Gebel Barkal. Preliminary remarks on the results of season 2004 and 2005. In: Godlewski, W. and A. Łajtar (eds.): *Between the Cataracts. Proceedings of the 11th Conference of Nubian Studies, Warsaw University, 27 August–2 September 2006. Polish Archaeology in Mediterranean, Supplement Series volume 2 part 2, fasc. 1.* Warsaw: 187–204.
- Baud, M. (2008): The Meroitic royal city of Muweis: first steps into an urban settlement of riverine Upper Nubia, *Sudan & Nubia* 12: 52–63.
- Baud, M. (2010): Méroé, un monde urbain. In: Baud, M. (ed.): *Méroé. Un empire sur le Nil.* Paris: 211–224.
- Costin, C. L. (1991): Craft specialization: Issues in defining, documenting, and explaining the organization of production. In: Schiffer, M. (ed.): *Archaeological Method and Theory*, vol. 3. Tuscon: 1–56.
- Crawford, O. G. S. and F. Addison (1951): *Abu Geili. The Wellcome Excavations in the Sudan* 3. Oxford.
- Daszkiewicz, M. and M. Wetendorf (2014): A new series of laboratory analyses of coarse wares from 'pottery courtyard' 224 of the Great Enclosure in Musawwarat es-Sufra (Sudan), *Der antike Sudan. MittSAG* 24: 99–104.
- Dittrich, A. (2003): Meroitische und spätmeroitische Keramik aus Hamadab, *Der antike Sudan. MittSAG* 14: 77–91.
- Edwards, D. (1998): Report on the Musawwarat pottery, 1997, *MittSAG* 8: 62–67.
- Edwards, D. N. (1999): A Meroitic Pottery Workshop at Musawwarat es Sufra. Preliminary Report on the Excavations 1997 in Courtyard 224 of the Great Enclosure. *Meroitica* 17,2: Musawwarat es Sufra III. Wiesbaden.
- Gerullat, I. (2001): Zusammenfassender Bericht zur vorläufigen Dokumentation der Keramikfunde der Ausgrabungskampagnen in den Jahren 1960 bis 1968 in Musawwarat es Sufra, *Der antike Sudan. MittSAG* 12: 64–79.
- Hintze, F. (1968): Musawwarat es Sufra. Vorbericht über die Ausgrabungen des Instituts für Ägyptologie der Humboldt-Universität, 1963 bis 1966 (vierte bis sechste Kampagne), *Wissenschaftliche Zeitschrift der Humboldt-Universität zu Berlin, Gesellschafts- und Sprachwissenschaftliche Reihe* 17: 667–684.
- Hintze, F. (1967–1968): Musawwarat es Sufra. Report on the excavations of the Institute of Egyptology, Humboldt University, Berlin, 1963–1966 (fourth to sixth seasons), *Kush* 15: 283–298.
- Hintze, F. and U. Hintze (1970): Einige neue Ergebnisse der Ausgrabungen des Instituts für Ägyptologie der Humboldt-Universität zu Berlin in Musawwarat es



- Sufra. In: Dinkler, E. (ed.): Kunst und Geschichte Nubiens in christlicher Zeit. Recklinghausen: 49–65.
- Näser, C. (2013): Die Feldkampagne der Archaeological Mission to Musawwarat im Frühjahr 2013, Der antike Sudan. MittSAG 24: 7–14.
- Näser, C. and M. Daszkiewicz (2013): New data from the ceramic workshop in courtyard 224 of the Great Enclosure in Musawwarat es Sufra, Der antike Sudan. MittSAG 24: 15–22.
- Näser, C. and M. Wetendorf (2014): The Musawwarat pottery project 2014, Der antike Sudan. MittSAG 25: 73–93.
- Onasch, H.-U. (2004): Die Keramikwerkstatt im Hof 224. In: Wenig, St. (ed.), Neueste Feldforschungen im Sudan und in Eritrea. Akten des Symposiums vom 13. bis 14. Oktober 1999 in Berlin. Meroitica 21. Wiesbaden: 63–70.
- Otto, K.-H. (1967): Zur Klassifikation der meroitischen Keramik von Musawwarat es-Sufra (Republik Sudan), Zeitschrift für Archäologie 1: 1–32.
- Powell, C. (1995): The nature and use of Ancient Egyptian potter's wheels. In: Kemp, B. (ed.): Amarna Reports VI. London: 309–318.
- Rose, P. (1998): The pottery. In: Edwards, D. N.: Gabati. A Meroitic, post-Meroitic and Medieval Cemetery in Central Sudan, vol. 1. London: 138–193.
- Seiler, A. (1998): Feine meroitische Ware aus Musawwarat es Sufra. Erste Ergebnisse der Bearbeitung der Keramik aus Hof 224 der Grossen Anlage, MittSAG 8: 56–61.
- Seiler, A. (1999): Die Keramik – Form und Funktion. In: Fitzenreiter, M.: Die Kleine Anlage. Meroitica 17,1: Musawwarat es Sufra II. Wiesbaden: 53–78.
- Shinnie, P. L. and R. J. Bradley (1980): The Capital of Kush I. Meroe Excavations 1965–1972. Meroitica 4. Berlin.
- Smith, S. T. (2014): A potter's wheelhead from Askut and the organization of the Egyptian ceramic industry in Nubia, Journal of the American Research Center in Egypt 50: 103–121.
- Török, L. (1997): Meroe City. An Ancient African Capital. London.
- Wenig, St. and P. Wolf (1998a): Feldarbeiten des Seminars für Sudanarchäologie und Ägyptologie der Humboldt-Universität in Musawwarat es Sufra. Erste Hauptkampagne, 16.10.1995 – 13.1.1996, MittSAG 8: 24–37.
- Wenig, St. and P. Wolf (1998b): Feldarbeiten des Seminars für Sudanarchäologie und Ägyptologie der Humboldt-Universität in Musawwarat es Sufra. Zweite Hauptkampagne, 1.2.1996 – 1.4.1996, MittSAG 8: 38–49.
- Wenig, St. and P. Wolf (1999): Feldarbeiten des Seminars für Sudanarchäologie und Ägyptologie der Humboldt-Universität in Musawwarat es Sufra. Dritte Hauptkampagne, 13.1.1997 – 11.4.1997, MittSAG 9: 24–43.
- Williams, B. (1991): Meroitic Remains from Qustul Cemetery Q, Ballana Cemetery B, and Ballana Settlement. Oriental Institute Nubian Expedition 8. Chicago.
- Wolf, P. (1997): Recent fieldwork at Musawwarat es Sufra, Sudan & Nubia 1: 20–29.
- Wolf, S. et al. (2009): Meroë und Hamadab – Stadtstrukturen und Lebensformen im afrikanischen Reich von Kusch. Die Arbeiten der Kampagnen 2008 und 2009, Archäologischer Anzeiger 2009/2: 215–262.
- Wolf, S. et al. (2011): Meroë und Hamadab – Stadtstrukturen und Lebensformen im afrikanischen Reich von Kusch. Die Arbeiten der Kampagne 2010, Archäologischer Anzeiger 2011/2: 213–245.

ZUSAMMENFASSUNG

Der Beitrag präsentiert die Ergebnisse der diesjährigen Arbeiten des Musawwarat Pottery Project. Vorgestellt werden:

- die Befunde der Grabungen in Schnitt 224.15 im ‚Keramikhof‘ 224, in Raum 225 sowie in Schnitt 224.N4 außerhalb der Umfassungsmauer der Großen Anlage
- erste Resultate der Analyse der Keramik und der Kleinfunde aus Schnitt 224.15
- die Ergebnisse der begleitenden geophysischen Prospektion sowie
- die Ergebnisse einer ethnoarchäologischen Studie in einer rezenten Keramikwerkstatt in Shendi.

In dem westlich der Schnitte 224.12 und 224.14 angelegten Schnitt 224.15 setzte sich das Keramikdeposit in leicht verminderter Stärke fort. Die in dem neuen Schnitt dokumentierte Stratigraphie belegt zehn Nutzungsepisoden bzw. -phasen:

- eine frühe Nutzung, die durch die vermutlich als Feuerstelle genutzte Grube 224.15-026 bezeugt ist
- die Ablagerung der schluffig-sandigen Schicht 224.15-020/025
- den Bau der Umfassungsmauer 224/N, die laut Hintze zur 6. Baustufe gehört
- die Anlage der Gruben 224.15-010, -014, -030 und -031, die in die Schichten 224.15-020/025 eingegraben sind
- die Anlage des Begehungshorizonts/Fußbodens 224.15-009
- den Bau der Lehmziegelstruktur 224.15-007 und ihre Nutzung im Zusammenhang mit dem zweiten Begehungshorizont/Fußboden 224.15-006
- die Zerstörung und möglicherweise den Rückbau dieser Ziegelstruktur sowie die Ablagerung einer geringen Menge Versturzmateriale (224.15-013)



- die Anlage des untersten Teil des Deposits bestehend aus den Schichten 224.15-024, -023, -008 und -033
- die Anlage des Hauptteils des Deposits (224.15-002, -004, -005, -015, -022), vermutlich in einer (relativ raschen) Folge von Einzelereignissen
- die Aufgabe des Areal und die Ablagerung eines Pakets sandiger Schichten (224.15-027, -001), die teilweise mit Funden durchmischt sind und von verschiedenen späteren Ereignissen, die durch die Kontexte 224.15-016, -017 und -018 bezeugt sind, gestört wurden.

Diese Abfolge ergänzt die in den Schnitten 224.12 and 224.14 dokumentierte Stratigraphie und kann mit neuen 14C-Datierungen chronologisch weiter fixiert werden. Die älteste durch die Grube 224.15-026 repräsentierte Phase datiert in das 4. oder 3. Jahrhundert v. Chr. Nur wenig jünger, nämlich aus dem 4. bis frühen 2. Jahrhundert v. Chr., ist die untere Fußbodenstrate, 224.15-009, auf der die Ziegelstruktur errichtet wurde. Zwei weitere Daten für die Gruben 224.15-010 und -030 sind dazwischen anzusiedeln. Zwei Daten aus den unteren Schichten des Deposits, 224.15-023 und -024, weisen in das 1. oder 2. Jahrhundert n. Chr. und damit an das Ende der 2014 an Hand von Material aus Schnitt 224.14 ermittelten Datierungsspanne für das Hauptdeposit.

Die Keramik aus Schnitt 224.15 umfasst ca. 14.000 Scherben mit einem Gesamtgewicht von 500 kg, von denen weniger als 6% Feinware und nur 0,55% handgemacht sind. Die Formenvielfalt ist begrenzt und entspricht im Wesentlichen dem Repertoire aus den benachbarten Schnitten 224.14 und 224.12. Trotzdem konnten einige neue Gefäßformen und Dekormotive erfasst werden, wie beispielsweise Opferständer, eine Schnabeltasse, ein Frosch-Stempelmotiv und eine durch Kammeindrücke gestaltete Figur (Rind). Im Bereich der Feinware sind Schalen die häufigste Formengruppe, hinzukommen einige Becher und Flaschen sowie die Schnabeltasse. Die Gefäße besitzen gewöhnlich einen Überzug, der meist weiß/cremefarben bis hellpink, in einigen Fällen orange bis rot ist. Im Gegensatz zu dem 2014 aufgenommenen Material konnte kein gelber Überzug dokumentiert werden. Gefäßoberflächen können poliert sein, vor allem wenn sie einen Überzug aufweisen. Stempeldekor findet sich im analysierten Korpus nicht nur auf Schalen, sondern auch auf Bechern und einer Flasche. Stempel-motive umfassen das übliche, auch andernorts belegte Repertoire. Erstmals wurden in Musawwarat jedoch zwei unterschiedliche Stempel-motive auf einem Gefäß dokumentiert. Gemaltes Dekor – vor allem geometrische und florale Motive

– ist auf allen Gefäßformen innerhalb der Feinware anzutreffen. Gefäßformen der scheibengedrehten Grobkeramik sind vor allem Schalen und Teller, Krüge und Flaschen sowie wenige Deckel, kleine Teller und Opferständer. Einige Henkel-fragmente und ein spitz zulaufender Boden können möglicherweise Amphoren zugeschrieben werden. Sofern ein Überzug vorhanden oder erhalten ist, dominiert rot. Dekorationen können eingeritzt oder aufgemalt sein. Ritzverzierungen treten vor allem in Form einfacher Linien im Randbereich von großen Schalen und Tellern sowie als wellenförmiger Dekore auf Krügen auf. Gemaltes Dekor umfasst Bänder auf der Schulter von Bierkrügen und Flaschen sowie religiöse Zeichen (*anch*) auf Flaschen. Der Anteil handgemachter Keramik ist sehr gering und auf einfache Schalen- und Krugformen beschränkt. Lediglich die Schalen können Kammstichverzierungen, teils in Kombination mit eingeritztem Dekor aufweisen. In sehr vereinzelt Fällen wurden die Kammeindrücke mit weißer Farbe gefüllt. Motive sind meist geometrisch, in einem Fall figürlich (Rinderdarstellung).

Die Bestimmung der Fabrics des vorliegenden Korpus baut auf einer 2014 durchgeführten archäometrischen Analyse von 34 Keramikproben scheibengedrehter und handgemachter Grobkeramik aus Schnitt 224.14 auf. Diese Serie hatte gezeigt, dass der größte Teil der scheibengedrehten Grobkeramik aus Material derselben geologischen Ursprungsregion bestand und daher eine lokale Produktion repräsentieren sollte. Im Gegensatz dazu ist ein großer Teil der handgemachten Keramik aus Niltonen hergestellt und somit importiert. Die Klassifikation der Grobwaren in vier Kategorien – 1. lokale Waditone der Referenzgruppe Mus4, 2. möglicherweise lokale oder regionale Waditone, 3. Niltone unterschiedlicher Herkunft und 4. verschiedene Tone unterschiedlicher Herkunft – konnte für den vorliegenden Korpus erfolgreich übernommen werden. Bei der scheibengedrehten Grobkeramik dominieren lokale Waditone der Referenzgruppe Mus4, wenige Gefäße sind Waditonen lokaler oder regionaler Herkunft zuzuordnen. Handgemachte Keramik im vorliegenden Material besteht hauptsächlich aus Niltonen unterschiedlicher Herkunft und verschiedenen Tönen unterschiedlicher Herkunft. Einige handgemachte Gefäße sind aus lokalen oder regionalen Waditonen gefertigt, sehr vereinzelt auch aus Waditonen der Referenzgruppe Mus4.

Obwohl Keramik die Mehrzahl der Funde aus dem Deposit ausmacht, wurde auch eine vergleichsweise große Zahl von Kleinfunden geborgen, darunter verschiedene Objekte und Materialien, die mit der Herstellung von Keramik in Verbindung



gebracht werden können, allen voran sechs neue Stempel zur Dekoration der typischen meroitischen Feinware.

Die Nachgrabung in Raum 225 erbrachte verschiedene Befunde aus frühen Nutzungsphasen und einer Phase, die mit hoher Wahrscheinlichkeit mit der in Hof 224 bezeugten Keramikproduktion korreliert. In diese Phase gehört ein ca. 2.1 x 1.3 m großes Becken, das zur Aufbereitung oder Lagerung von Ton gedient haben könnte, sowie ein kleiner durch eine niedrige Mauer abgetrennter Bereich, in dem bei der Erstgrabung 1965/66 das Unterteil einer Töpferscheibe entdeckt worden war.

Geophysikalische Untersuchungen wurden eingesetzt, um in Hof 224 und umliegenden Areale die Existenz von Töpferöfen und anderen Installationen, die mit der Keramikproduktion in Verbindung gestanden haben könnten, zu eruieren. Das Ergebnis war negativ – es wurden nur wenige Anomalien verzeichnet, und keiner der Befunde deutet auf Ofeninstallationen hin.

Diese Beobachtung wurde durch eine Grabung außerhalb der Umfassungsmauer, Schnitt 224.N4, weiter erhärtet. Die freigelegte stratigrafische Sequenz zeigt lediglich eine massive Sandakkumulation und auf Fundamentoberkante der Umfassungsmauer eine einzelne Schicht, die Asche, Keramik und Tierknochen enthielt. Dieser Befund wird jedoch durch einen Einzelfund relativiert: aus der Sandschicht, das heißt aus sekundärer Fundlage, wurde ein Schlackestück von ca. 8 cm Durchmesser geborgen, das noch den Abdruck eines Schmelzriegels bewahrt (224.N4-003-003).

Einen weiteren Strang der Untersuchung bildete eine ethnoarchäologische Studie, die der Frage nachging, ob das Deposit in Hof 224 das Ergebnis eines offenen Grubenbrands darstellen könnte. Zu diesem Zweck wurde der Brandplatz einer rezenten Töpferwerkstatt in Shendi in einer Testgrabung untersucht. Das dokumentierte Profil zeigt eine von den Befunden im ‚Keramikhof‘ 224 abweichende Sequenz, mit klar voneinander abgegrenzten sandig-aschigen Schichten, die vermutlich individuellen Brennepisoden zuzuordnen sind und durch Ablagerungen anderer Materialien voneinander getrennt sind.

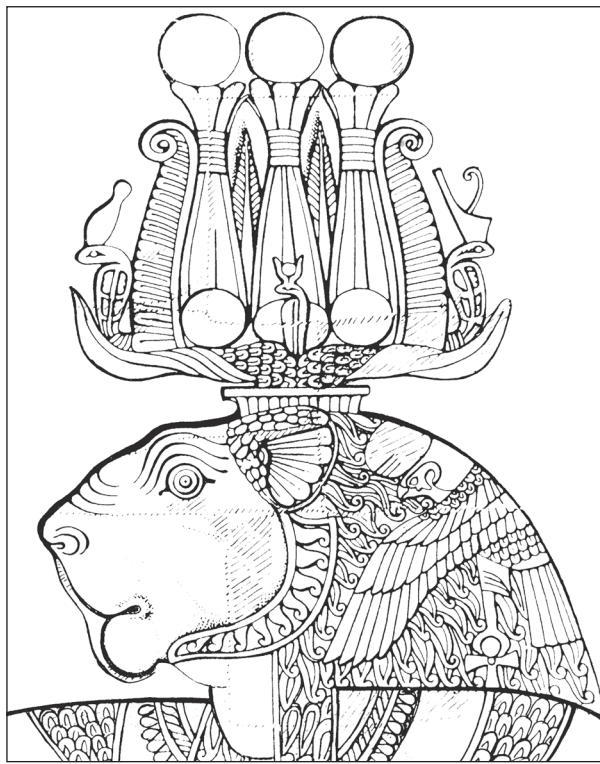
In der Summe deuten die aktuell erhobenen Befunde darauf hin, dass die in den Schnitten 224.14 und 224.15 freigelegte Ziegelstruktur und die Brandflecken aufweisenden Fußbodenstraten tatsächlich im direkten Zusammenhang mit dem Brennen von Keramik stehen. Dass der mit diesem Bereich assoziierte Abschnitt der Umfassungsmauer 224/N durch Hitzeeinwirkung partiell zerstört ist, stützt diese These weiter. Ähnliche Befunde sind bereits an ver-

schiedenen Stellen der Mauern in Hof 224 erhoben worden, was wiederum auf eine ‚wandernde‘ Nutzung des Areals hindeutet. Das Deposit würde damit den Abfall eines neuen Brandplatzes, im unteren Teil vermischt mit anderen Produktionsabfällen, der auf einem aufgegebenen älteren Brandplatz abgelagert wurde, darstellen.

Um weitere Daten zu dem Brandprozess, vor allem zu den Befeuerungsmaterialien und den im Brand erzielten Temperaturen zu gewinnen, wurde die Matrix des Deposits selbst archäometrisch untersucht. Dabei stellte sich heraus, dass es sich nicht um Asche, also um Verbrennungsrückstände organischer Materialien, sondern um Mullit handelt. Mullit ist ein Silikatmineral, das sich unter bestimmten Bedingungen beim Brennen von Porzellan und kaolinhaltiger Keramik bildet. Mit diesem Erstdachweis von Mullit in der Archäologie des Niltals wurde ein neues Kapitel in der Analyse der antiken Keramikherstellung und ihrer technologischen Parameter in dieser Region aufgeschlagen.

Die chronologische Einordnung der mit der Keramikproduktion assoziierten Kontexte in das späte 1. Jahrhundert v. Chr. oder das 1. Jahrhundert n. Chr. macht Musawwarat zum ältesten datierten Nachweis für die Produktion der typischen meroitischen Feinware. Es steht zu hoffen, dass weitere Grabungen und die aktuell fortgesetzten Analysen von Rohmaterialien, Produktionsabfällen und der Keramik selbst die Grundlage bilden können, um offene Fragen zu klären und die erzielten Ergebnisse in den kommenden Projektphasen zu vertiefen und zu erweitern.

MITTEILUNGEN DER
SUDANARCHÄOLOGISCHEN
GESELLSCHAFT ZU BERLIN E.V.



HEFT 26
2015



HERAUSGEBER:	Sudanarchäologische Gesellschaft zu Berlin e.V. c/o Humboldt-Universität zu Berlin Institut für Archäologie – Lehrbereich Ägyptologie und Archäologie Nordostafrikas Unter den Linden 6 • 10099 Berlin
VERANTWORTLICH FÜR DIE HERAUSGABE:	Angelika Lohwasser
LAYOUT & SATZ:	Frank Joachim
ERSCHEINUNGSORT:	Berlin
INTERNETPRÄSENZ:	www.sag-online.de
BANKVERBINDUNG DER SAG:	Deutsche Bank 24 AG BLZ 100-700-24 BIC DEUTDE3333 Kto.-Nr. 055-55-08 IBAN DE36100700240055550800

Die Zeitschrift DER ANTIKE SUDAN (MittSAG) erscheint einmal im Jahr und wird an die Mitglieder der Sudanarchäologischen Gesellschaft kostenlos abgegeben. Preis pro Heft: 19,50 Euro + Versandkosten. Die in den Beiträgen geäußerten Ansichten geben nicht unbedingt die Meinung des Herausgebers wieder. Die „Richtlinien für Autoren“ finden Sie unter www.sag-online.de, wir senden sie auf Anfrage auch gerne zu.

© 2015 Sudanarchäologische Gesellschaft zu Berlin e.V.
Nachdruck, auch auszugsweise, nur mit Genehmigung der Gesellschaft.

SUDANARCHÄOLOGISCHE GESELLSCHAFT ZU BERLIN E.V.

Angesichts der Tatsache, daß die globalen wirtschaftlichen, ökonomischen und politischen Probleme auch zu einer Gefährdung der kulturellen Hinterlassenschaften in aller Welt führen, ist es dringend geboten, gemeinsame Anstrengungen zu unternehmen, das der gesamten Menschheit gehörende Kulturerbe für künftige Generationen zu bewahren. Eine wesentliche Rolle bei dieser Aufgabe kommt der Archäologie zu. Ihre vornehmste Verpflichtung muß sie in der heutigen Zeit darin sehen, bedrohte Kulturdenkmäler zu pflegen und für ihre Erhaltung zu wirken.

Die Sudanarchäologische Gesellschaft zu Berlin e.V. setzt sich besonders für den Erhalt des Ensembles von Sakralbauten aus meroitischer Zeit in Musawwarat es Sufra/Sudan ein, indem sie konservatorische Arbeiten unterstützt, archäologische Ausgrabungen fördert sowie Dokumentation und Publikation der Altertümer von Musawwarat ermöglicht. Wenn die Arbeit der Sudanarchäologischen Gesellschaft zu Berlin Ihr Interesse geweckt hat und Sie bei uns mitarbeiten möchten, werden Sie Mitglied! Wir sind aber auch für jede andere Unterstützung dankbar. Wir freuen uns über Ihr Interesse!

Mitgliedsbeiträge jährlich:
Vollmitglied: € 65.- | Ermäßiggt: € 35.- | Student: € 15.- | Fördermitglied: mind. € 250.-

ISSN 0945-9502

Der antike Sudan. Mitteilungen der Sudanarchäologischen Gesellschaft zu Berlin e.V.

Kurzcode: MittSAG

Heft 26 • 2015



EDITORIAL	5
ÜBERSICHTSKARTE	6
NACHRICHTEN AUS MUSAWWARAT	
Claudia Näser <i>Site management at Musawwarat es-Sufra 2014/15: concepts, measures and perspectives</i>	7
Peter Becker <i>Löwentempel Musawwarat es-Sufra – die Renovierung des Dachtragwerks 2014/15</i>	27
Claudia Näser & Manja Wetendorf <i>The Musawwarat pottery project 2014/15</i>	35
FRITZ-HINTZE-VORLESUNG	
Friederike Jesse <i>Bollwerk im Niemandsland: Die Festung Gala Abu Ahmed zur Zeit der Pharaonen</i>	75
AUS DER ARCHÄOLOGIE	
Yahia Fadol Tahir & Ahmed Hamid Nassr <i>Paleolithic stone tools of El-Ga'ab depression A techno-typological study from the surface collection</i>	95
Angelika Lohwasser, Jana Eger & Tim Karberg <i>Das Projekt Wadi Abu Dom Itinerary (W.A.D.I.) Kampagne 2015</i>	109
Annett Dittrich, Kerstin Geßner, Sayantani Neogi, Maciej Ehlert & Nadine Nolde <i>Holocene stratigraphies and sediments on Mogratt Island (Sudan) – The second season of the Late Prehistoric Survey 2014/15</i>	123
Jens Weschenfelder <i>The Terminal Neolithic cemetery in the funerary landscape of MOG034, Mogratt Island, Sudan</i>	145
Jens Weschenfelder <i>Preliminary report of the second and third field seasons at the Bronze Age cemetery MOG034 on Mogratt Island, Sudan</i>	153
Tina Jakob <i>Preliminary Bioarchaeological Analysis of the Human Remains from Mogratt Island (MOG034), 2014 and 2015</i>	169
Gareth Rees, Miriam Lahitte & Claudia Näser <i>The Fortresses of Mogratt Island Project</i>	177
Gemma Tully <i>Community Archaeology in Sudan: Discovering Mogratt Island together</i>	201



VARIA

- Uwe Sievertsen
Die Profanarchitektur der napatanschen Epoche 205
- Kumiko Saito
*The matrilineal royal Succession in the Empire of Kush: A new proposal Identifying
the Kinship Terminology in the 25th and Napatans Dynasties as that of Iroquois/Crow* 233
- Angelika Lohwasser
Khonsu sitting IN Jebel Barkal 245
- Uroš Matić
Die „römischen“ Feinde in der meroitischen Kunst 251
- Joanna Then-Obłuska
“Jewels of Ancient Nubia” – a glance through the eye bead from Berenike 263
- Alexey K. Vinogradov
The Many-Eyed Thinker from Meroe 267
- Michael H. Zach
Meroe in der österreichischen Reiseliteratur des 19. Jahrhunderts 277